



COAXIAL SOLID STATE

Digital Step Attenuator **ZX76-65G-30-E+**

50Ω 0 to 31.5 dB 0.5 dB Step 0.1 to 65 GHz 1.85 mm Female
6 Bit Parallel Control Interface Dual or Single Supply Voltage

THE BIG DEAL

- Ultra-Wideband Coverage, 0.1 to 65 GHz
- Immune to Latch-Up
- High IIP3, +50 dBm
- Good Return Loss, 15 dB typ.
- Glitch-less Attenuation Transitions
- Dual +3.3, -3V or Single Supply Voltage +3.3V



Generic photo used for illustration purposes only

APPLICATIONS

- Test and Measurement
- 4G LTE & 5G FR1, FR2 & FR2+ Satellite Infrastructure Communications
- WiFi6E, IoT, UWB, and SATCOM
- Communications, Radar, EW, and ECM Defense Systems

FUNCTIONAL DIAGRAM

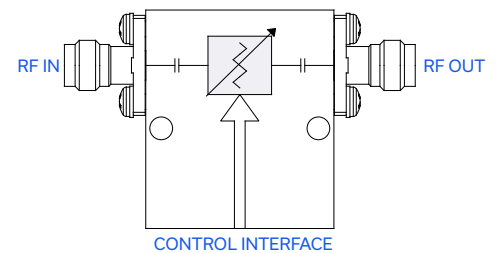

PRODUCT OVERVIEW

The ZX76-65G-30-E+ is a 50Ω Digital Step Attenuator that provides adjustable attenuation from 0 to 31.5 dB in 0.5 dB steps. The control is a 6-bit parallel interface, with a single positive or a dual, positive and negative supply voltage. The model is produced using a unique package design for ruggedness and operation in tough environments.

KEY FEATURES

Features	Advantages
Wideband operation, 0.1 to 65 GHz	Can be used in multiple applications such as communications, satellite and defense reducing part count.
Parallel control interface with wide control voltage range	Uses a simple parallel control interface with no clock required.
Good return loss, 15 dB typ.	Eases interfacing with adjacent components and results in low amplitude ripple.
Glitch-less attenuation transitions	The ZX76-65G-30-E+ employs novel architecture to reduce the RF output power spikes during attenuation transition to 0.3 dB (typ.) thus reducing noise in the system and eliminating the risk of a transient spike damaging sensitive components in the system.
Single positive supply is available	The use of a single positive supply simplifies power supply design. An internal negative voltage generator supplies the desired negative voltage. Single positive supply results in excellent spurious performance. For applications that require the lowest possible spur performance negative voltage can be applied externally to bypass the internal negative voltage generator.
Wide positive power supply +2.3 to +5.5 V	Model suitable for both +5 V and +3.3 V systems applications with no need for voltage dividers or multipliers.





COAXIAL SOLID STATE

Digital Step Attenuator **ZX76-65G-30-E+**

Mini-Circuits

50Ω 0 to 31.5 dB 0.5 dB Step 0.1 to 65 GHz 1.85 mm Female
6 Bit Parallel Control Interface Dual or Single Supply Voltage

RF ELECTRICAL SPECIFICATIONS¹, 100 MHz - 65 GHz, $T_{AMB}=+25^{\circ}\text{C}$, $V_{DD}=+3.3\text{ V}$

Feature	Frequency (GHz)	Min.	Typ.	Max.	Units
Insertion Loss @ 0dB Attenuation Setting	0.1 - 15	—	3.0	7.0	dB
	15 - 35	—	5.5	8.5	
	35 - 50	—	7.5	11.5	
	50 - 65	—	9.5	13.5	
Input IP3 ²	2 - 16	—	+50	—	dBm
Input Power @ 1 dB Compression	0.1 - 65	+22	—	—	dBm
Return Loss	0.1 - 65	—	15	—	dB

1. Attenuator RF ports are interchangeable, and support simultaneous, bidirectional signal transmission, however the specifications are guaranteed for the RF In and RF Out as noted on the label. There may be minor changes in performance when injecting signals to the RF Out port.

2. Tested with 1 MHz offset between signals, +18 dBm per tone.

NOMINAL ATTENUATION & ATTENUATION ACCURACY, $T_{AMB}=+25^{\circ}\text{C}$, $V_{DD}=+3.3\text{ V}$

Attenuation Setting	Nominal Attenuation (typ.)					Typical Attenuation Accuracy Relative to Nominal Attenuation				
	0.1 GHz	15 GHz	30 GHz	45 GHz	65 GHz	0.1 GHz	15 GHz	30 GHz	45 GHz	65 GHz
0.5 dB	0.47	0.45	0.30	0.36	0.32	±0.15	±0.15	±0.25	±0.20	±0.20
1 dB	0.90	0.88	0.70	0.50	0.57	±0.20	±0.20	±0.30	±0.35	±0.25
2 dB	2.20	2.1	2.5	2.8	2.3	±0.30	±0.30	±0.75	±0.60	±0.55
4 dB	4.1	4.2	4.0	4.0	4.3	±0.30	±0.45	±0.55	±0.80	±0.85
8 dB	8.20	8.3	8.4	8.7	8.5	±0.50	±0.80	±0.90	±1.00	±1.00
16 dB	16.30	16.7	16.7	17.7	18.1	±1.00	±1.40	±1.40	±1.50	±1.80
31.5 dB	32.20	32.6	32.8	32.9	33.6	±1.10	±1.30	±2.50	±2.80	±3.20

DC ELECTRICAL SPECIFICATIONS

Parameter	Min.	Typ.	Max.	Units
Positive Supply Voltage, V_{DD}	+2.3 ³	+3.3	+5.4	V
Positive Supply Current, I_{DD}	—	170	250	μA
Negative Supply Voltage, V_{SS}	-3.3	-3.0	-2.7	V
Negative Supply Current, I_{SS}	-40	-16	—	μA
Control Input Low	-0.3	—	+0.6	V
Control Input High	+1.17	—	+5.3	V
Control Current	—	10	20	μA

3. Minimum positive supply voltage (V_{DD}) is +3.1V when negative supply voltage (V_{SS}) is applied externally.

SWITCHING SPECIFICATIONS

Parameter	Min.	Typ.	Max.	Units
Switching Speed, 50% Control to 0.5 dB of Attenuation Value	—	330	400	nsec

ABSOLUTE MAXIMUM RATINGS⁴

Parameter	Ratings
Operating Temperature	0°C to 50°C
Storage Temperature	-20°C to 85°C
V_{DD}	-0.3V Min., +5.5V Max.
V_{SS}	-3.6V Min., +0.3V Max.
Voltage on any control input	-0.3V Min., +3.6V Max.
ESD, HBM ⁶	1000 V
Maximum Input Power ⁷	+28 dBm

4. Permanent damage may occur if any of these limits are exceeded. Operating in the range between operating power limits and absolute maximum ratings for extended periods of time may result in reduced life and reliability.

6. Human body model (MIL-STD 883 Method 3015)

7. $T_{ambient} = +25^{\circ}\text{C}$, derate to +26 dBm @ +50°C





COAXIAL SOLID STATE

Digital Step Attenuator **ZX76-65G-30-E+**



50Ω 0 to 31.5 dB 0.5 dB Step 0.1 to 65 GHz 1.85 mm Female
6 Bit Parallel Control Interface Dual or Single Supply Voltage

TYPICAL PERFORMANCE DATA AT $T_{AMB}=+25^{\circ}C$, $V_{DD}=+3.3 V$

Freq. (GHz)	Input Return Loss (dB) @ Attenuation Setting								Output Return Loss (dB) @ Attenuation Setting							
	0 dB	0.5 dB	1.0 dB	2.0 dB	4.0 dB	8.0 dB	16 dB	31.5 dB	0 dB	0.5 dB	1.0 dB	2.0 dB	4.0 dB	8.0 dB	16 dB	31.5 dB
0.1	17.4	21.2	27.9	12.1	20.1	38.7	33.0	32.7	17.5	20.7	24.2	13.1	33.1	22.0	48.8	30.0
0.5	16.7	20.3	25.9	11.9	19.5	39.3	34.0	33.8	17.0	20.0	23.1	13.0	30.9	21.5	36.3	30.4
1	16.7	20.2	25.8	11.9	19.5	38.3	33.5	33.3	17.1	20.0	23.0	13.1	31.3	21.5	34.6	30.1
5	17.3	20.1	24.8	11.9	17.8	28.6	29.3	29.5	18.5	20.3	20.7	13.8	25.9	17.4	22.9	30.3
10	21.6	21.9	22.4	16.2	20.8	18.9	18.1	18.1	23.3	21.9	19.7	24.6	22.9	23.8	19.2	18.4
15	24.3	24.7	25.6	16.6	21.6	20.3	19.5	19.3	15.3	15.8	14.9	15.5	22.3	15.5	19.6	29.0
20	18.8	17.4	15.6	40.0	20.0	15.1	15.1	14.8	23.2	20.5	19.4	27.4	22.1	18.5	14.7	17.9
25	10.8	10.6	9.7	13.8	12.3	10.6	11.0	11.1	14.9	15.9	17.2	13.0	13.0	15.0	16.7	13.5
30	14.3	15.3	15.8	10.9	13.3	14.2	13.9	14.1	14.1	13.6	13.2	19.4	17.8	16.9	19.8	20.5
35	12.2	12.5	14.1	10.2	13.2	16.1	16.0	15.7	12.5	12.2	11.9	16.4	14.3	15.9	16.7	16.9
40	14.6	14.6	16.2	13.5	16.3	20.9	21.9	21.3	13.6	13.1	13.4	16.0	14.2	16.4	14.9	16.2
45	24.7	22.7	25.2	18.2	22.1	35.2	34.4	32.1	21.4	20.8	23.2	15.8	20.1	15.8	12.8	16.8
50	15.1	14.6	16.2	13.5	14.7	19.1	19.1	18.2	16.4	16.2	17.3	13.1	14.8	13.1	11.3	13.2
55	15.0	14.4	14.4	21.3	14.1	16.5	16.2	17.1	11.9	12.3	11.5	12.2	14.6	12.8	11.5	14.2
60	15.9	15.1	14.9	21.2	14.2	17.1	16.6	17.4	13.7	13.5	13.3	15.5	13.4	13.8	16.6	14.3
65	18.6	18.0	18.2	36.1	20.7	22.3	23.0	23.1	10.0	10.2	10.2	9.4	9.5	10.6	9.7	9.4

TYPICAL PERFORMANCE DATA AT $T_{AMB}=+25^{\circ}C$, $V_{DD}=+3.3 V$

Frequency (GHz)	Insertion Loss (dB)	Attenuation Relative to Insertion Loss (dB) @ Attenuation Setting						
		0 dB	0.5 dB	1.0 dB	2.0 dB	4.0 dB	8.0 dB	16 dB
0.1	1.36	0.47	0.89	2.18	4.22	8.18	16.33	32.31
0.5	1.51	0.48	0.90	2.17	4.23	8.19	16.35	32.29
1	1.61	0.48	0.91	2.16	4.23	8.20	16.36	32.31
5	2.37	0.41	0.80	2.31	4.13	8.09	16.22	32.17
10	3.46	0.46	0.87	2.19	4.18	8.18	16.45	32.43
15	3.89	0.48	0.91	2.10	4.16	8.33	16.71	32.59
20	4.66	0.41	0.83	2.05	4.03	8.26	16.73	32.67
25	5.44	0.28	0.71	2.41	4.17	8.45	16.68	32.89
30	5.70	0.28	0.62	2.54	4.05	8.36	16.72	32.71
35	6.27	0.29	0.62	2.47	4.01	8.40	16.76	32.74
40	7.00	0.33	0.61	2.31	3.93	8.28	16.79	32.49
45	7.33	0.35	0.50	2.68	4.00	8.65	17.61	32.88
50	8.16	0.34	0.51	2.63	4.05	8.71	18.02	34.46
55	8.82	0.32	0.68	2.29	4.06	8.88	18.37	34.59
60	9.59	0.40	0.59	2.45	4.50	9.02	18.77	33.29
65	11.11	0.32	0.61	2.34	4.37	8.72	18.72	32.49





COAXIAL SOLID STATE

Digital Step Attenuator **ZX76-65G-30-E+**

50Ω 0 to 31.5 dB 0.5 dB Step 0.1 to 65 GHz 1.85 mm Female
6 Bit Parallel Control Interface Dual or Single Supply Voltage

TYPICAL PERFORMANCE DATA AT $T_{AMB}=+25^{\circ}\text{C}$, $V_{DD}=+3.3\text{ V}$

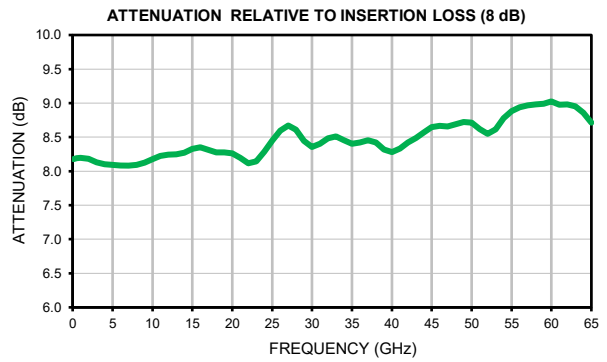
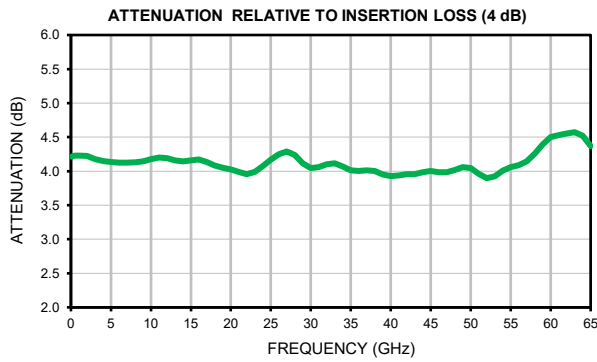
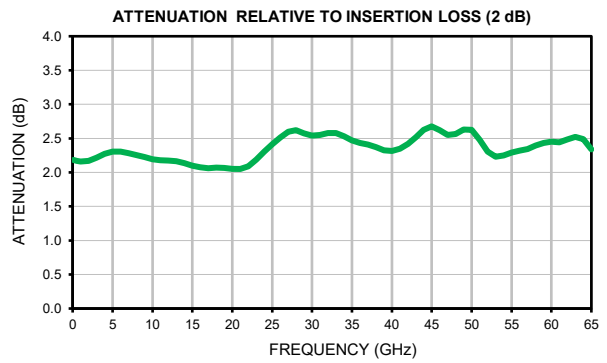
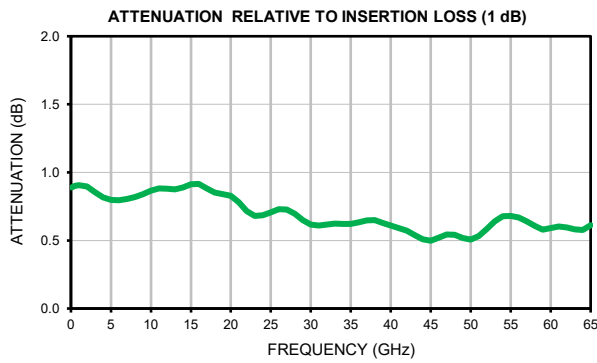
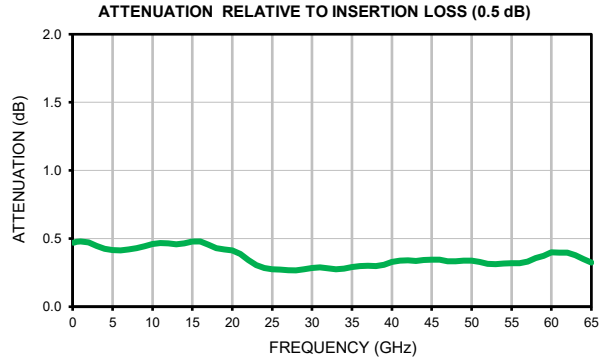
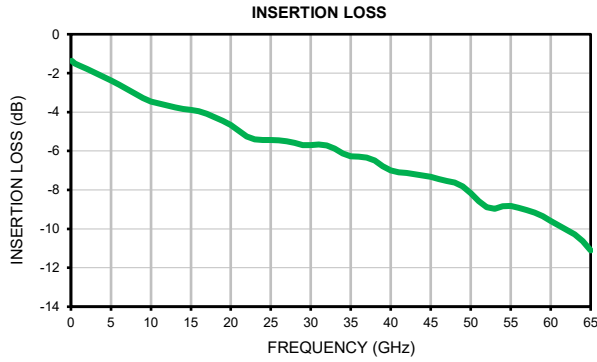



COAXIAL SOLID STATE

Digital Step Attenuator ZX76-65G-30-E+

50Ω 0 to 31.5 dB 0.5 dB Step 0.1 to 65 GHz 1.85 mm Female
6 Bit Parallel Control Interface Dual or Single Supply Voltage

TYPICAL PERFORMANCE DATA AT $T_{AMB}=+25^{\circ}\text{C}$, $V_{DD}=+3.3\text{ V}$

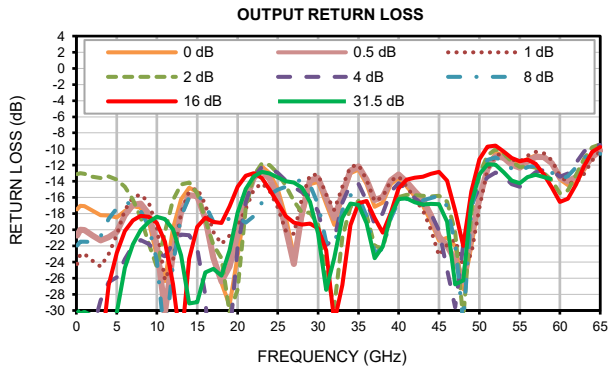
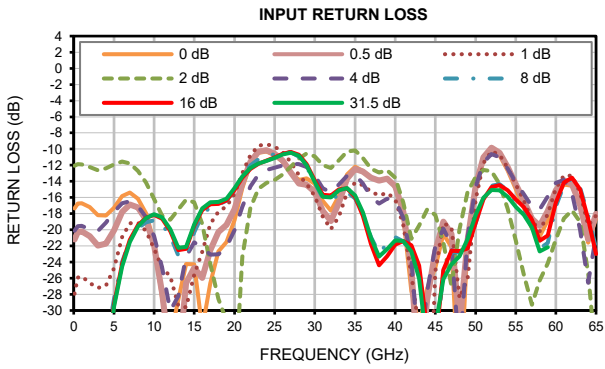
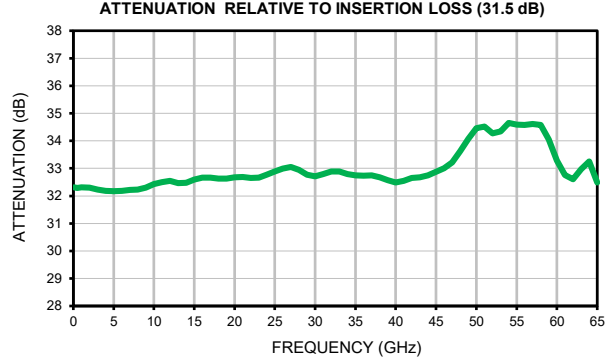
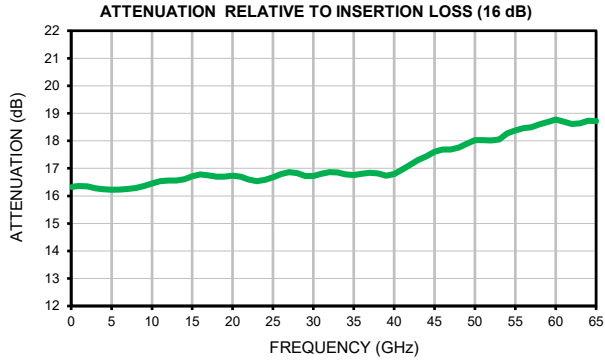



COAXIAL SOLID STATE

Digital Step Attenuator

ZX76-65G-30-E+

Mini-Circuits

50Ω 0 to 31.5 dB 0.5 dB Step 0.1 to 65 GHz 1.85 mm Female
6 Bit Parallel Control Interface Dual or Single Supply Voltage

PIN CONFIGURATION (TOP VIEW)

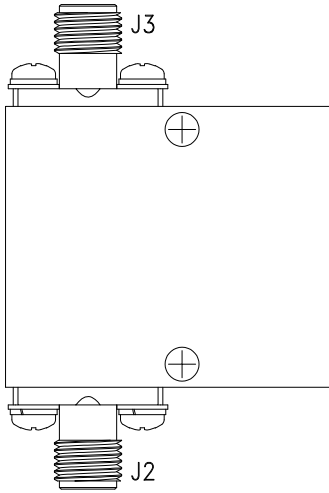

PIN DESCRIPTION

Connector	Function	Pin Number	Description
Digital Control Receptacle	LE	J1-1	Latch Enable Input
	P/S	J1-2	Logic Low (0V) ³
	C0.5	J1-3	Control for attenuation bit, 0.5 dB
	C1	J1-4	Control for attenuation bit, 1.0 dB
	C4	J1-5	Control for attenuation bit, 4.0 dB
	C2	J1-6	Control for attenuation bit, 2 dB
	C8	J1-7	Control for attenuation bit, 8 dB
	C16	J1-8	Control for attenuation bit, 16 dB
	V _{DD}	J1-9	Positive Supply Voltage
	V _{SS}	J1-10	Negative Supply Voltage ² (or ext gnd)
Coaxial	IN	J2	RF in port ¹
	OUT	J3	RF out port ¹

Note 1: Both RF ports are DC blocked with internal series capacitors.

Note 2: The internal negative voltage is generated when Pin J1-10 is grounded.

Note 3: J1-2 Must be tied low before applying any control bit.

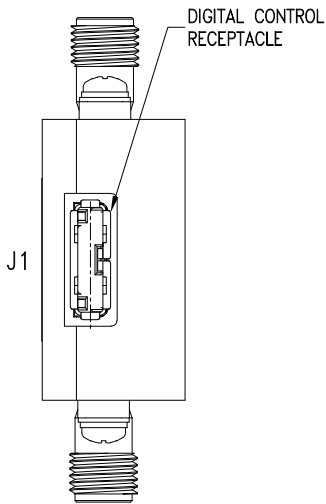



COAXIAL SOLID STATE

Digital Step Attenuator **ZX76-65G-30-E+**

50Ω 0 to 31.5 dB 0.5 dB Step 0.1 to 65 GHz 1.85 mm Female
6 Bit Parallel Control Interface Dual or Single Supply Voltage

CASE STYLE DRAWING

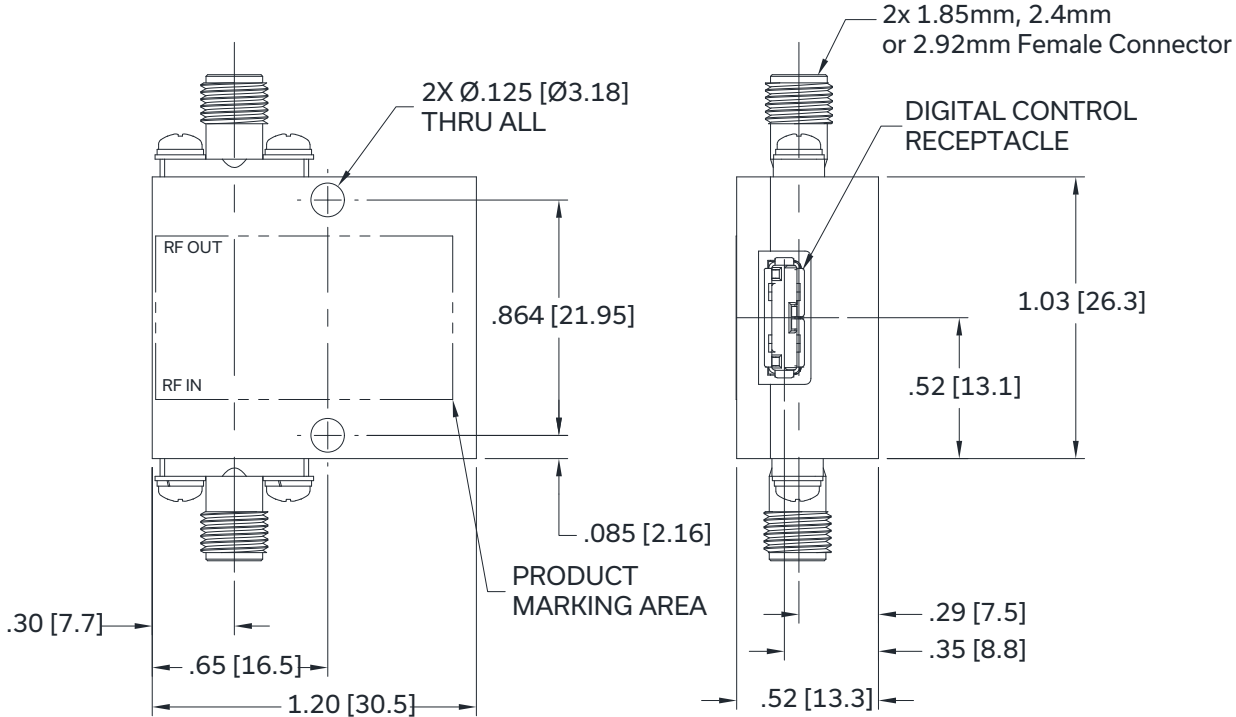

Weight: 45.36 grams

Dimensions are in inches [mm]. Tolerances: 2Pl.±.03; 3Pl. ± .015

PRODUCT MARKING

Product Marking: ZX76-65G-30-E+

Marking may contain other features or characters for internal lot control



COAXIAL SOLID STATE

Digital Step Attenuator ZX76-65G-30-E+

50Ω 0 to 31.5 dB 0.5 dB Step 0.1 to 65 GHz 1.85 mm Female
6 Bit Parallel Control Interface Dual or Single Supply Voltage

SIMPLIFIED SCHEMATIC

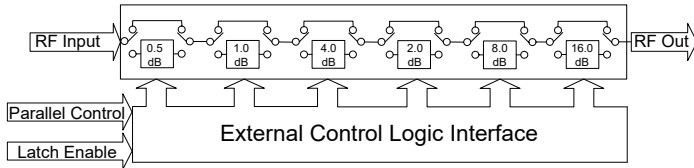

The ZX76-65G-30-E+ parallel interface consists of 6 control bits that select the desired attenuation state, as shown in Table 1: Truth Table.

TABLE 1. TRUTH TABLE

Attenuation State	C16	C8	C4	C2	C1	C0.5
Reference	0	0	0	0	0	0
0.5 (dB)	0	0	0	0	0	1
1 (dB)	0	0	0	0	1	0
2 (dB)	0	0	0	1	0	0
4 (dB)	0	0	1	0	0	0
8 (dB)	0	1	0	0	0	0
16 (dB)	1	0	0	0	0	0
31.5 (dB)	1	1	1	1	1	1

Note: Not all 64 possible combinations of C0.5 - C16 are shown in table

The parallel interface timing requirements are defined by Figure 1 (Parallel Interface Timing Diagram) and Table 2 (Parallel Interface AC Characteristics), and the switching speed.

For latched parallel programming the Latch Enable (LE) should be held LOW while changing attenuation state control values, then pulse LE HIGH to LOW (per Figure 1) to latch new attenuation state into the device.

For direct parallel programming, the Latch Enable (LE) line should be pulled HIGH. Changing the attenuation state control values will immediately change the device's state to a new attenuation value. Direct mode is ideal for manual control of the device (using hardware, switches, or jumpers).

TABLE 2. PARALLEL INTERFACE AC CHARACTERISTICS

Symbol	Parameter	Min.	Units
t_{LEPW}	LE minimum pulse width	10	ns
t_{PDSUP}	Data set-up time before clock rising edge of LE	10	ns
t_{PDHLD}	Data hold time after clock falling edge of LE	10	ns

FIG. 1: PARALLEL INTERFACE TIMING DIAGRAM

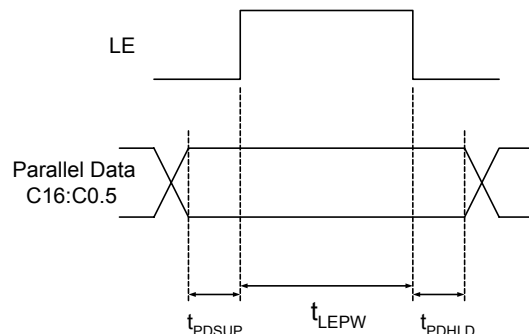

POWER-UP STATE

When the attenuator powers up and LE is logic low, the nominal attenuation is set to 31.5 dB. When LE is logic high, the nominal attenuation is selected based upon the preset control logic bits (see Table 1).



COAXIAL SOLID STATE

Digital Step Attenuator **ZX76-65G-30-E+**

50Ω 0 to 31.5 dB 0.5 dB Step 0.1 to 65 GHz 1.85 mm Female
6 Bit Parallel Control Interface Dual or Single Supply Voltage

INCLUDED ACCESSORY

CBL-5FT-MPD+ is a "Pigtail" connector included with every purchase of ZX76-65G-30-E+. CBL-5FT-MPD+ is a shielded cable with stripped wires (#32AWG) on one end and a connector on the other end designed to mate to the ZX76-65G-30-E+. These bare wires enable the customer to interface with the ZX76-65G-30-E+ (cable length is 4.9ft/ 1.5meters).

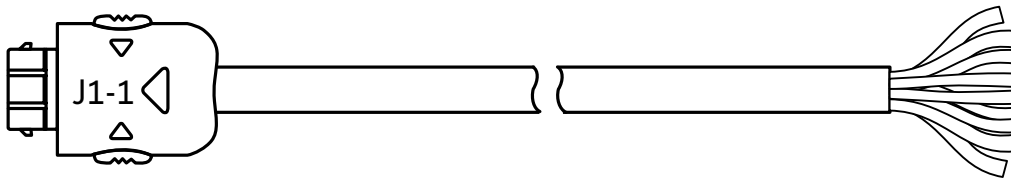

CBL-5FT-MPD+ WIRING INFORMATION

J1-1 Pin Number	Function	Description	Wire Color
1	LE	Latch Enable Input	Green
2	P/S	Latch Enable Input	Green/Black
3	C0.5	Control for attenuation bit, 0.5 dB	Red
4	C1	Control for attenuation bit, 1.0 dB	Orange
5	C4	Control for attenuation bit, 4.0 dB	Orange/Black
6	C2	Control for attenuation bit, 2.0 dB	Black
7	C8	Control for attenuation bit, 8.0 dB	Red/Black
8	C16	Control for attenuation bit, 16.0 dB	Blue
9	V _{DD}	Positive Supply Voltage	White
10	V _{SS}	Negative Supply Voltage (or ext ground)	White/Black
Shield	-	Shield Braid/ Drain	-

Note: Cable shield connected to case ground.



COAXIAL SOLID STATE

Digital Step Attenuator **ZX76-65G-30-E+**

50Ω 0 to 31.5 dB 0.5 dB Step 0.1 to 65 GHz 1.85 mm Female
6 Bit Parallel Control Interface Dual or Single Supply Voltage

ADDITIONAL DETAILED INFORMATION IS AVAILABLE ON OUR DASH BOARD [CLICK HERE](#)

Performance Data & Graphs	Data
	Graphs
	S-Parameter (S2P Files) Data Set (.zip file)
Case Style	MS3009
RoHS Status	Compliant
Environmental Ratings	ENV55T1
Export Info	EAR99

INCLUDED ACCESSORY

Photo	
Part No.	CBL-5FT-MPD+
Description	5 ft. (1.5M) Control Cable
Quantity	1

- NOTES**
- A. Performance and quality attributes and conditions not expressly stated in this specification document are intended to be excluded and do not form a part of this specification document.
 - B. Electrical specifications and performance data contained in this specification document are based on Mini-Circuit's applicable established test performance criteria and measurement instructions.
 - C. The parts covered by this specification document are subject to Mini-Circuits standard limited warranty and terms and conditions (collectively, "Standard Terms"); Purchasers of this part are entitled to the rights and benefits contained therein. For a full statement of the standard. Terms and the exclusive rights and remedies thereunder, please visit Mini-Circuits' website at www.minicircuits.com/terms/viewterm.html

