1.3M USB Camera

STC-S133UVC Color CMOS Cameras

STC-S133UVC-BL	(1.3M / No lens mount / IR Cut Filter / Board)
STC-S133UVC-BLL	(1.3M / M12 lens mount / IR Cut Filter / Board)
STC-S133UVC-BLCS	(1.3M / CS mount / IR Cut Filter / Board)
STC-S133UVC-DBL	(1.3M / No lens mount / Dual Pass Filter / Board)
STC-S133UVC-DBLL	(1.3M / M12 lens mount / Dual Pass Filter / Board)
STC-S133UVC-DBLCS	(1.3M / CS mount / Dual Pass Filter / Board)
STC-S133UVC-ALL	(1.3M / M12 lens mount / IR Cut Filter / Cased)
STC-S133UVC-ALCS	(1.3M / CS mount / IR Cut Filter / Cased)
STC-S133UVC-DALL	(1.3M / M12 lens mount / Dual Pass Filter / Cased)
STC-S133UVC-DALCS	(1.3M / CS mount / Dual Pass Filter / Cased)

Product Specifications and User's Guide

OMRON SENTECH CO., LTD.

Table of Contents

1	Product Precautions	7
2	Warranty	7
3	Introduction	8
3.1	Features	8
3.2	Product Number Naming Method	8
4	Specifications	9
4.1	Electronic specifications	9
4.2	Spectral Sensitivity Characteristics	11
4.2.1	CMOS Sensor Spectral Sensitivity Characteristics	11
4.2.2	IR Cut Filter Spectral Sensitivity Characteristics (STC-S133UVC-BL / STC-S133UVC-BLL / STC-S133UVC-BLCS / STC-S133UVC-ALL / STC-S133UVC-ALCS).....	12
4.2.3	Dual Pass Filter Spectral Sensitivity Characteristics (STC-S133UVC-DBL / STC-S133UVC-DBLL / STC-S133UVC-DBLCS / STC-S133UVC-DALL / STC-S133UVC-DALCS).....	12
4.3	Mechanical Specifications.....	13
4.3.1	STC-S133UVC-BL / STC-S133UVC-DBL	13
4.3.2	STC-S133UVC-BLL / STC-S133UVC-DBLL	13
4.3.3	STC-S133UVC-BLCS / STC-S133UVC-DBLCS.....	13
4.3.4	STC-S133UVC-ALL / STC-S133UVC-DALL	13
4.3.5	STC-S133UVC-ALCS / STC-S133UVC-DALCS.....	14
4.4	Environmental Specifications	14
4.5	Connector specifications.....	15
4.5.1	STC-S133UVC-BL / STC-S133UVC-BLL / STC-S133UVC-BLCS / STC-S133UVC-DBL / STC-S133UVC-DBLL / STC-S133UVC-DBLCS	15
4.5.2	STC-S133UVC-ALL / STC-S133UVC-ALCS / STC-S133UVC-DALL / STC-S133UVC-DALCS	15
4.6	To use the camera	16
4.6.1	Windows system.....	16
4.6.2	Linux system	16
4.7	Other.....	17
5	Dimensions	18
5.1	STC-S133UVC-BL / STC-S133UVC-DBL	18

5.2	STC-S133UVC-BLL / STC-S133UVC-DBLL	19
5.3	STC-S133UVC-BLCS / STC-S133UVC-DBLCS	20
5.4	STC-S133UVC-ALL / STC-S133UVC-DALL	21
5.5	STC-S133UVC-ALCS / STC-S133UVC-DALCS	22
6	Communication control software users guide	23
6.1	Requirement software.....	23
6.2	Connecting configuration.....	23
6.3	Communication settings.....	23
6.4	Basic operating procedure	24
6.5	The descriptions for the buttons	25
	Read All.....	25
	DSP -> FLASH.....	25
	Reset.....	25
6.6	The descriptions of the functions	26
	Menue	26
	Shutter/Gain Tab.....	27
	Lens Tab	30
	OSD Tab	32
	WDR Tab.....	34
	AE Weight Tab	36
	Normal AE Tab.....	37
	Full ME Tab.....	38
	AE Mask Tab.....	39
	WhiteBalance Tab.....	40
	Gamma Tab	42
	Chroma Tab	43
	Other Tab	44
	Privacy Mask Tab.....	45
	Day&Night Tab.....	47
	Aperture Tab	48
	Analog Tab.....	48
	Blemish Pixel Tab	49
	Info. Tab	49
	Field Table.....	49
	One Shot.....	50
7	Camera setting by the OSD.....	51

7.1	OSD operation by camera control software.....	51
7.1.1	OSD menu	52
	SETUP MENU.....	52
	SHUTTER/AGC	53
	WHITE BAL.....	54
	PICT ADJUST	56
	DEFOG.....	57
	WDR/ATR.....	58
	Day/Night	59
	DNR.....	59
	PRIVACY.....	60
	LANGUAGE	61
	CAMERA RESET	61
	SAVE ALL.....	61
8	Revisions History	62

Precautions for safe use

Please read carefully this "Precautions for safe use" before use the camera. Then the camera uses correctly with agreeing with below notes.

In this "Precautions for safe use", notes divides into "Warning" and "Caution" to use the camera safety and prevent to harm and damage.

Warning	This shows, assumption for possibility of serious accident leading death or serious injury if ignore this note and camera uses incorrectly.
Caution	This shows, assumption for possibility of bear the damage or physical damage if ignore this note and camera uses incorrectly.

About Graphic symbols



This symbol shows general prohibition.







This symbol shows completion or instruction.

[Environment / condition]





Warning	
Do not use flammable or explosiveness atmospheres. This will cause of personal injury or fire.	Do not use for "safety for human body" related usage. This camera is designed for use "do not harm human body immediately" if by any chance the camera has malfunction.
Caution	
Use and store under specified environmental conditions (Vibration, shock, temperature, humidity) in the specifications for this camera. This will cause of fire or damage the camera.	



[Installation and cable wiring]

Warning	
Do not use with out of power voltage range that is specified in the specifications for this camera. This will cause of fire, electrification or malfunction.	Do not wrong wiring. This will cause of fire or malfunction.



 Caution	
 Do not grounding DC power (+) of all devices that are connect to the camera. The camera housing is connecting to 0 V line of camera inside circuit. There is a risk of short circuit between camera inside ciurcuit and frame ground. This will cause of malfunction.	 It is necessary to wiring and mounting that is specified in the specifications for this camera. This will cause of fire or malfunction.
 It is necessary to wiring with turn off the camera. This will cause of electrification or malfunction.	 It is necessary to mounting the camera without stress for the cable. This will case of electrification or fire.

[Usage instruction]



 Warning	
 Do not touch the terminal and PCB board While turn on the camera. This will cause of electrification or accident caused by malfunction.	 Do not put combustibles near the camera. This will cause of fire.
 Do not use without usage that is specified in the specifications for this camera. This will cause of personal injury or malfunction.	 Do not push metals including screw driver into radiation holes. This will cause of electrification or malfunction.

 Caution	
 Do not push contamination into opening of the camera. This will cause of electrification or malfunction.	 Do not block the radiation holes. This will cause of fire due to increase the camera inside temperature.

[Maintenance]

 Caution	
 Do not disassemble or repair the camera. This will cause of fire, electrification or malfunction.	 It is turn off the camera when maintaining or inspecting the camera. This will cause of electrification.

[Disposal]

 Caution	
 It is necessary to dispose as industrial waste.	

1 Product Precautions

- Do not give shock to the camera.
 - Do not haul or damage the camera cable.
 - Do not wrap the camera with any material while using the camera. This will cause the internal camera temperature to increase.
 - When the camera moving or using the place that temperature difference is extreme, countermeasure for dew condensation (heat removal / cold removal) is necessary.
 - While the camera is not using, keep the lens cap on the camera to prevent dust or contamination from getting in the sensor or filter and scratching or damaging it.
- Do not keep the camera under the following conditions.
- In wet, moist, high humidity or dusty place
 - Under direct sunlight
 - In extreme high or low temperature place
 - Near an object that releases a strong magnetic or electric field
 - Place with strong vibrations
- Apply the power that satisfies the specified in specifications for the camera.
 - The defective pixels may appear due to the sensor characteristics.
 - Use below recommend materials (or equivalent materials) to clean the surface of glass.
 - Air dust: Non Freon air duster (NAKABAYASHI Co., LTD.)
 - Alcohol: Propan-2-ol (SAN'EI KAKO Co., LTD.)
 - Non-woven: nikowipe clean room (NKB)
 - Use a soft cloth to clean the camera.

2 Warranty

■Warranty period

One year after delivery (However, the camera had malfunction with camera uses correctly)
In below case for a fee even within warranty period.

- The malfunction caused by incorrect usage, incorrect modify or repair.
- The malfunction caused by external shock including the camera dropping after delivery the camera.
- The malfunction caused by fire, earthquake, flood disaster, thunderbolt struck, other natural disaster or wrong voltage.

■Warranty coverage

Exchange or repair the malfunction camera if the malfunction is occurred by our responsibility.

“Warranty” mean is warranty for the delivered camera itself. Please accept the induction damage by the camera malfunction is not included.

3 Introduction

This document describes the specifications of the following cameras

STC-S133UVC-BL / STC-S133UVC-BLL / STC-S133UVC-BLCS	(IR Cut Filter, Board models)
STC-S133UVC-DBL / STC-S133UVC-DBLL / STC-S133UVC-DBLCS	(Dual Pass Filter, Board models)
STC-S133UVC-ALL / STC-S133UVC-ALCS	(IR Cut Filter, Cased models)
STC-S133UVC-DALL / STC-S133UVC-DALCS	(Dual Pass Filter, Cased models)

3.1 Features

- USB3.0 USB Video Class 1.1 compliant
- 1/3.2" 1.27M CMOS Sensor (Sony, ISX017)
- Small camera
- Gain, shutter and color adjustment functions
- Flip image function
- Day / Night function
- Lens vignetting and distortion correction
- Shading correction
- Configurable many parameters through the control software
- Wide dynamic range (ATR-EX) and defog function
- Pixel blemish correction
- OSCD (On Screen Character Display) is available for the parameters configuration (OSD)

3.2 Product Number Naming Method

STC-S133UVC-xBL

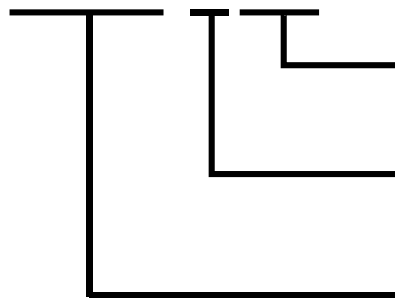

BL: Angle USB, No lens mount, Board
 BLL: Angle USB, M12 lens mount, Board
 BLCS: Angle USB, CS mount, Board
 ALL: Angle USB, M12 lens mount, Cased
 ALCS: Angle USB, CS mount, Cased

Optical Filter
 None: IR Cut Filter
 D: Dual Pass Filter

UVC: USB Video Class

4 Specifications

4.1 Electronic specifications

Model Number		STC-S133UVC-BL / STC-S133UVC-BLL / STC-S133UVC-BLCS / STC-S133UVC-DBL / STC-S133UVC-DBLL / STC-S133UVC-DBLCS STC-S133UVC-ALL / STC-S133UVC-ALCS / STC-S133UVC-DALL / STC-S133UVC-DALCS		
Image sensor		1/3.2" 1.27M Progressive CMOS (SONY ISX017)		
Video signal format		USB3.0	1,280 (H) x 720 (V) 60 / 50 / 30 / 25 fps, 1,280 (H) x 960 (V) 30 / 25 fps (Default: 1,280 (H) x 720 (V) 60 fps)	
		USB2.0	800 (H) x 600 (V) 25 fps, 640 (H) x 480 (V) 30 / 25 fps with image center ROI output (Default: 800 (H) x 600 (V) 25 fps)	
Chip size		USB3.0	4.48 (H) x 2.52 (V) mm (1,280 (H) x 720 (V)) / 4.48 (H) x 3.36 (V) mm (1,280 (H) x 960 (V))	
		USB2.0	2.80 (H) x 2.10 (V) mm (800 (H) x 600 (V)) / 2.24 (H) x 1.68 (V) mm (640 (H) x 480 (V))	
Cell size		3.5 (H) x 3.5 (V) μ m		
Shutter type		Rolling shutter		
Sensitivity (*1)		220 Lux		
Sync system		Internal		
Compliant standard		USB3.0 / USB2.0 USB Video Class (UVC) 1.1 Communication Device Class (CDC)		
Support OS		Windows 7,10 / Linux (Ubuntu, CentOS)		
Camera functions		Adjustable functions with UVC Viewer		
		Adjustable functions with communication		
		Electronic shutter	1/60 to 1/10,000 seconds Auto (Auto only for USB2.0)	1/60 (1/50) to 1/605,000 seconds Auto / Fixed
		Gain	AGC only	AGC / Fixed gain 0 to 40 dB
		White balance	Auto White Balance only	Auto white balance / Manual / Push to set
		Image flip	Horizontal and vertical flip only	Normal / Horizontal flip / Vertical flip / Horizontal and vertical flip
		Gamma	N/A	Manual / Straight
		Privacy masking	N/A	16 frames (Color, size and position are adjustable individually) (Default: Off)
		Color adjustment	Hue and saturation are adjustable	
		Image adjustment	Brightness and contrast are adjustable	
		Day / Night	N/A	Support
Lens correction	N/A	Vignetting, distortion and shading correction		
Others	Back light compensation / Flicker correction	Pixel blemish correction / WDR / Defog / Back light compensation / Flicker correction / High brightness correction / Noise reduction (2D) / Negative/Positive image / False color correction		
Communication		N/A	UART communication by CDC 115,200bps	
OSD		Available for USB3.0 connection with CDC		
Interface		USB3.0 micro B type connector		
Power		+5 V USB Bus power		
		Max: 1.0W, Typical 0.8 W		

Default: **Bold**

Precautions

(*1) The sensitivity is measuring the luminance when white level achieved 100 % in below conditions.

Camera Setting		Environment	
Parameter	Setting	Parameter	Setting
Gain Up	0 dB	Light Source	Light Box (White)
AGC	Off	Color temperature	5,100K
White Balance	Optimum	Lens	
Electrical Shutter	1/30 seconds	F on Lens	F5.6
Black Level	Optimum	Target Luminance	IM-600 (Topcon)
Gamma	Factory Setting		

4.2 Spectral Sensitivity Characteristics

4.2.1 CMOS Sensor Spectral Sensitivity Characteristics

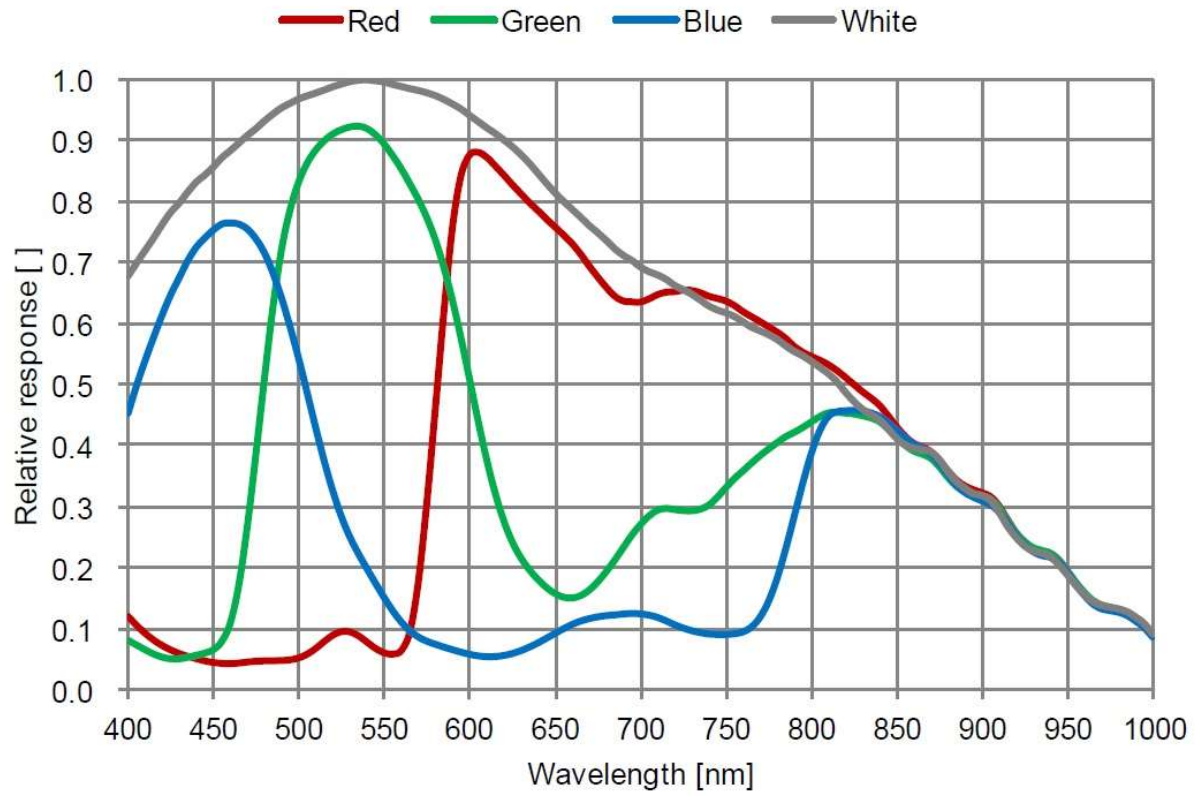

4.2.2 IR Cut Filter Spectral Sensitivity Characteristics (STC-S133UVC-BL / STC-S133UVC-BLL / STC-S133UVC-BLCS / STC-S133UVC-ALL / STC-S133UVC-ALCS)

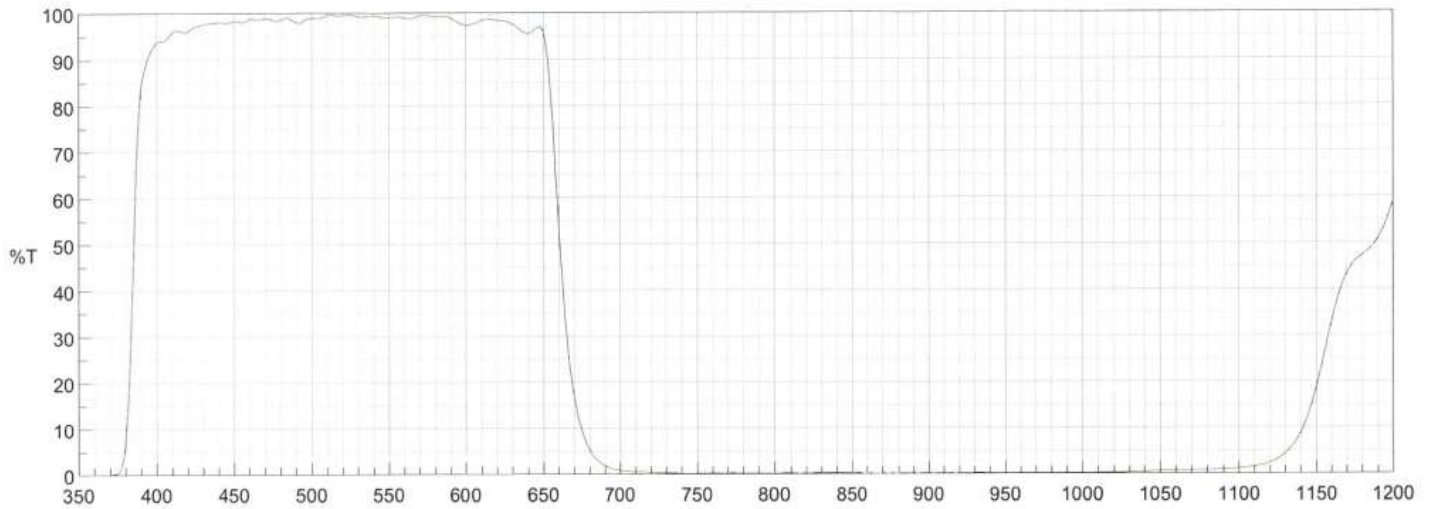

4.2.3 Dual Pass Filter Spectral Sensitivity Characteristics (STC-S133UVC-DBL / STC-S133UVC-DBLL / STC-S133UVC-DBLCS / STC-S133UVC-DALL / STC-S133UVC-DALCS)

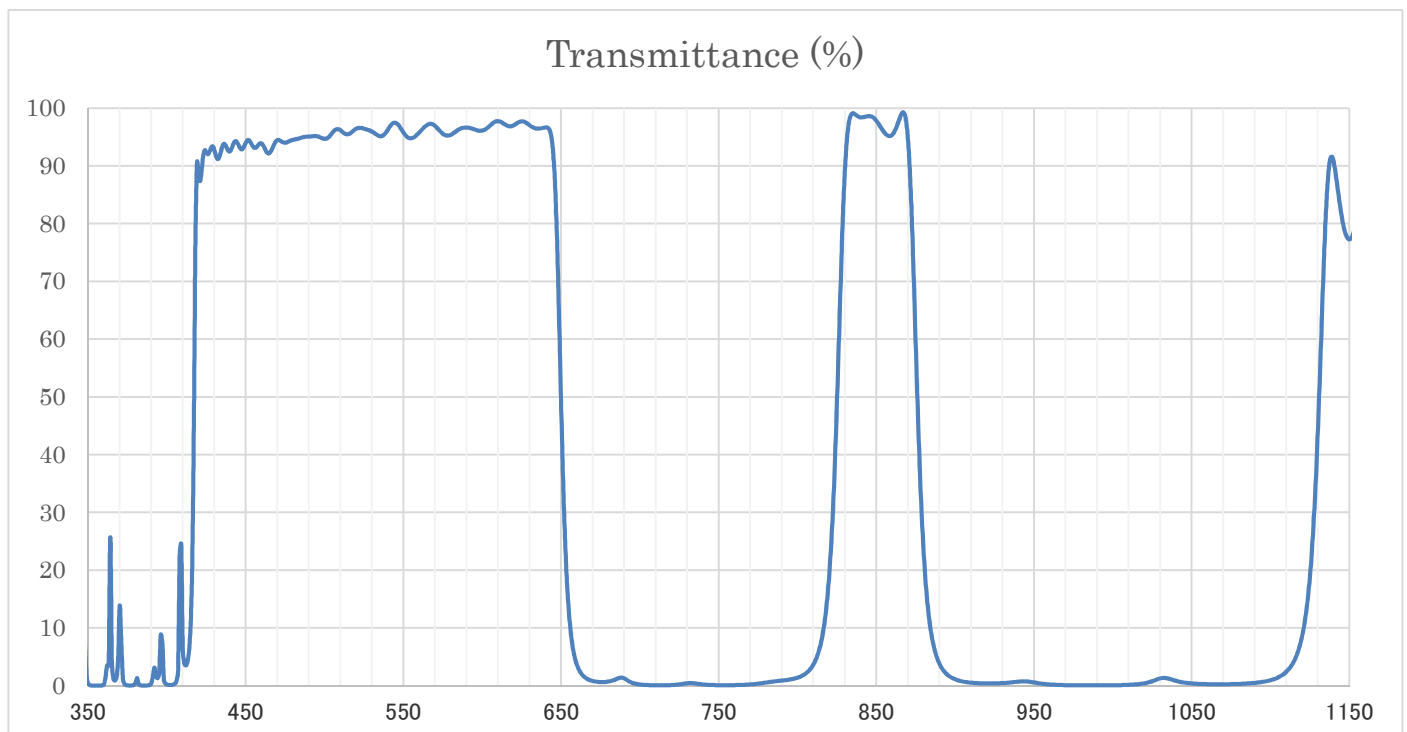

4.3 Mechanical Specifications

4.3.1 STC-S133UVC-BL / STC-S133UVC-DBL

Model Number	STC-S133UVC-BL	STC-S133UVC-DBL
Dimensions (*1)	23 (W) x 20 (H) x 15.1 (D) mm	
Optical Filter	IR Cut Filter built in	Dual Pass Filter built in
Lens Mount	No lens mount	
Camera Mounting	M2 screw holes (Four on front, two on top and bottom plate)	
Weight	Approximately 8 g	

(*1) Excluding projection

4.3.2 STC-S133UVC-BLL / STC-S133UVC-DBLL

Model Number	STC-S133UVC-BLL	STC-S133UVC-DBLL
Dimensions (*1)	25 (W) x 22 (H) x 24.5 (D) mm	
Optical Filter	IR Cut Filter built in	Dual Pass Filter built in
Lens Mount	M12 x P0.5	
Camera Mounting	M2 screw holes (Four on front, two on top and bottom plate)	
Weight	Approximately 13 g	

(*1) Excluding projection

4.3.3 STC-S133UVC-BLCS / STC-S133UVC-DBLCS

Model Number	STC-S133UVC-BLCS	/ STC-S133UVC-DBLCS
Dimensions (*1)	φ28 x 21.7 (D) mm	
Optical Filter	IR Cut Filter built in	Dual Pass Filter built in
Lens Mount	CS mount	
Camera Mounting	M2 screw holes (Two on Top and bottom plate)	
Weight	Approximately 12 g	

(*1) Excluding projection

4.3.4 STC-S133UVC-ALL / STC-S133UVC-DALL

Model Number	STC-S133UVC-ALL	STC-S133UVC-DALL
Dimensions (*1)	25 (W) x 25 (H) x 18 (D) mm	
Optical Filter	IR Cut Filter built in	Dual Pass Filter built in
Lens Mount	M12 x P0.5	
Camera Mounting	M2 screw holes (Four on front plate) M2.5 screw holes (Two on Top, bottom and both side plate)	
Weight	Approximately 23 g	

(*1) Excluding projection

4.3.5 STC-S133UVC-ALCS / STC-S133UVC-DALCS

Model Number	STC-S133UVC-ALCS	/ STC-S133UVC-DALCS
Dimensions (*1)	25 (W) x 25 (H) x 25.6 (D) mm	
Optical Filter	IR Cut Filter built in	Dual Pass Filter built in
Lens Mount	CS mount	
Camera Mounting	M2.5 screw holes (Two on Top, bottom and both side plate)	
Weight	Approximately 24 g	

(*1) Excluding projection

4.4 Environmental Specifications

Model Number	STC-S133UVC-BL / STC-S133UVC-BLL / STC-S133UVC-BLCS / STC-S133UVC-DBL / STC-S133UVC-DBLL / STC-S133UVC-DBLCS / STC-S133UVC-ALL / STC-S133UVC-ALCS / STC-S133UVC-DALL / STC-S133UVC-DALCS
Operational Temperature / Humidity	Environmental Temperature: 0 to +55 deg. C, Environmental Humidity: 0 to 80 %RH (No condensation)
Storage Temperature / Humidity	Environmental Temperature: -25 to +75 deg. C, Environmental Humidity: 0 to 80 %RH (No condensation)
Vibration	20 Hz to 200 Hz to 20 Hz (5 min. / cycle), acceleration 10 G, XYZ 3 directions 30 min. each
Shock	Acceleration 38 G, half amplitude 6 ms, XYZ 3 directions 3 times each
RoHS	RoHS Compliant

4.5 Connector specifications

4.5.1 STC-S133UVC-BL / STC-S133UVC-BLL / STC-S133UVC-BLCS / STC-S133UVC-DBL / STC-S133UVC-DBLL / STC-S133UVC-DBLCS

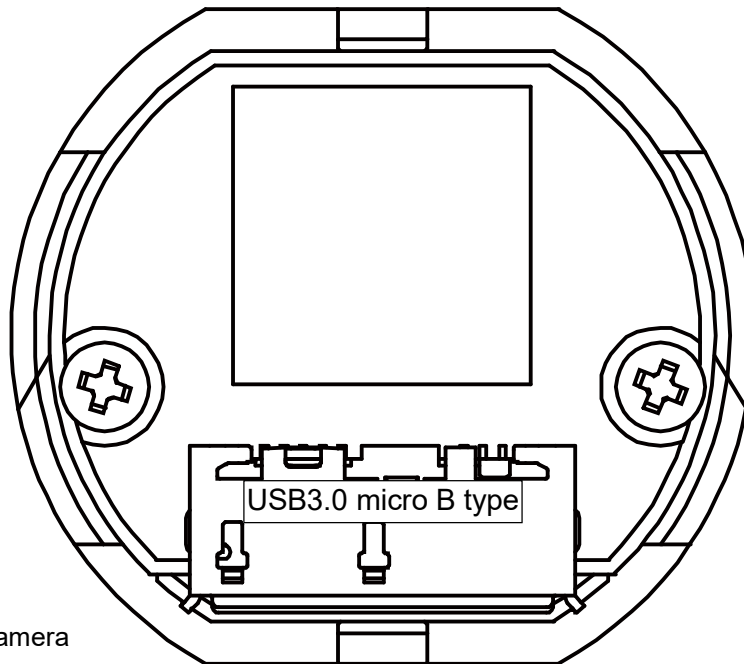

Bottom of camera

4.5.2 STC-S133UVC-ALL / STC-S133UVC-ALCS / STC-S133UVC-DALL / STC-S133UVC-DALCS

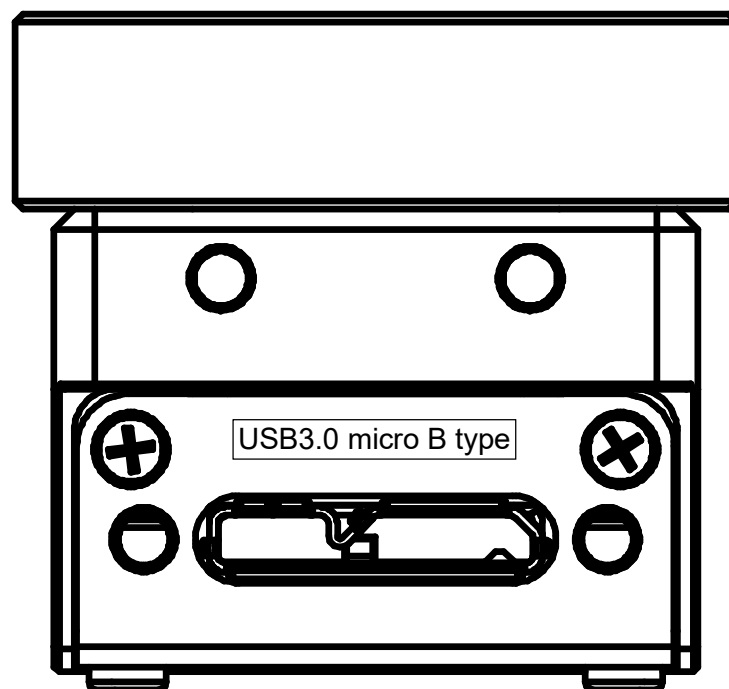

4.6 To use the camera

4.6.1 Windows system

Requirement software

- 1) Camera control software: KSACtrl (version 2.02 or newer)
- 2) OSD software: S133Control
(The camera settings are changeable with on screen display)

*** UVC camera supported viewer software (UVC Viewer) is required to obtain the image.**

Software installation

CDC driver for communicate to the camera, install before camera connects to the PC.
Please follow below procedure.

- 1) Install KSACtrl.
- 2) Install CDC driver by selecting "Install CDC driver" under "KSACtrl" under "Sentech" at Program menu.
Please select correct installer from 32bits (x86) or 64bit (x64).

*** CDC driver is installing automatically when the camera connecting to the Windows10 PC.
(CDC driver manual install is not necessary)**



- 3) The driver is installing automatically when the camera connects to PC after installed CDC driver.
The driver installing may take few minutes.
- 4) The camera disconnects from PC after installing the driver correctly.
- 5) The camera connects to PC.

The image can obtain by UVC Viewer and camera settings are changeable from KSACtrl or OSD software (S133Control)

4.6.2 Linux system

We've confirm the image with Cheesa and Gucvview on Ubuntu and CentOS Linux.
The camera settings are changeable from OSD software (S133Ctrl)

4.7 Other

When the camera connecting to USB2.0 port, the center ROI image is output and field of view becomes narrow.

USB3.0	1,280 (H) x 720 (V): 60 / 50 / 30 / 25 fps, 1,280 (H) x 960 (V): 30 / 25 fps
USB2.0	800 (H) x 600 (V) 25 fps, 640 (H) x 480 (V): 30fps / 25 fps * with the image center ROI output

When the camera connecting to USB2.0 port, the image stream may stop while camera settings are adjusting.

5 Dimensions

5.1 STC-S133UVC-BL / STC-S133UVC-DBL

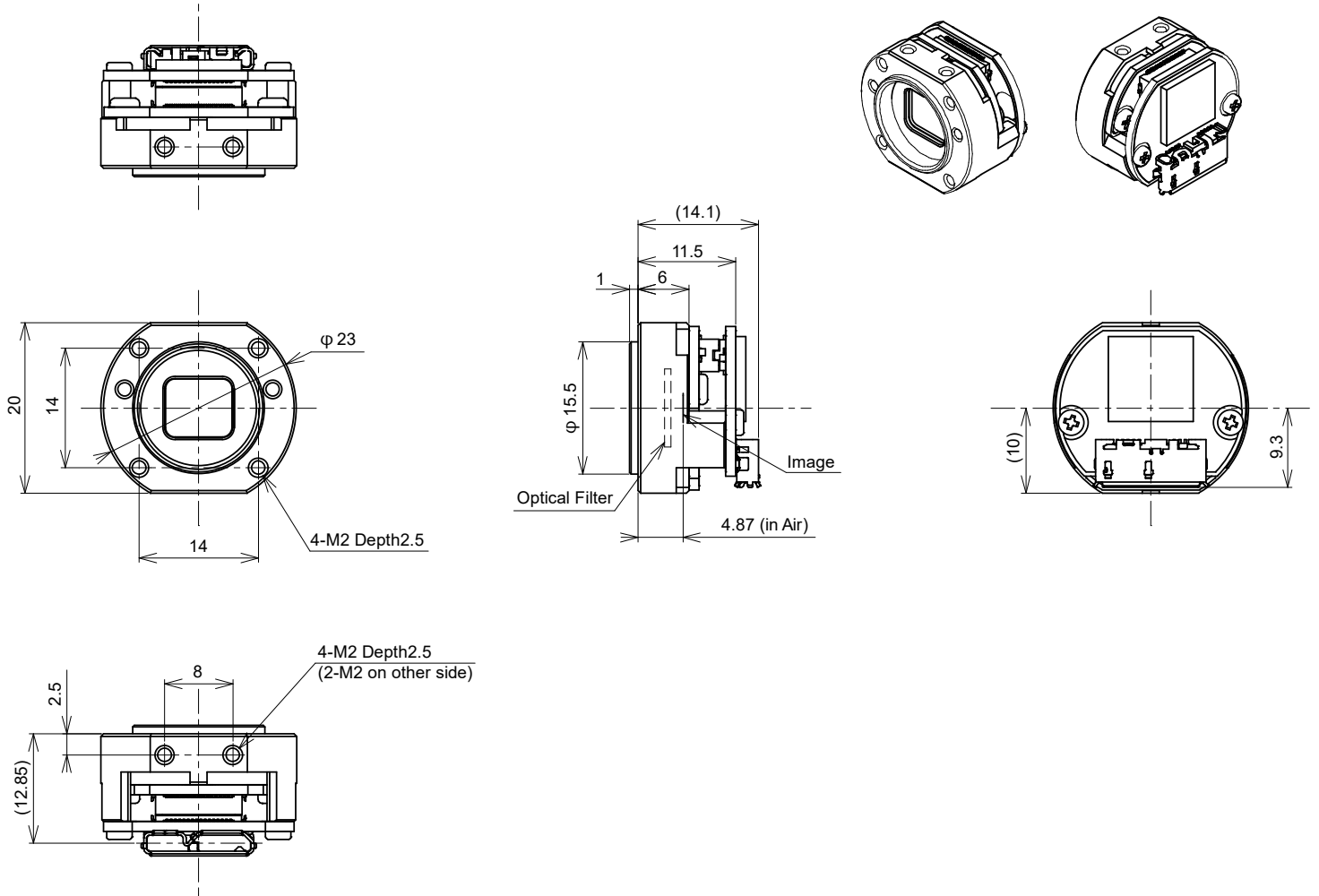

Unit: mm

5.2 STC-S133UVC-BLL / STC-S133UVC-DBLL

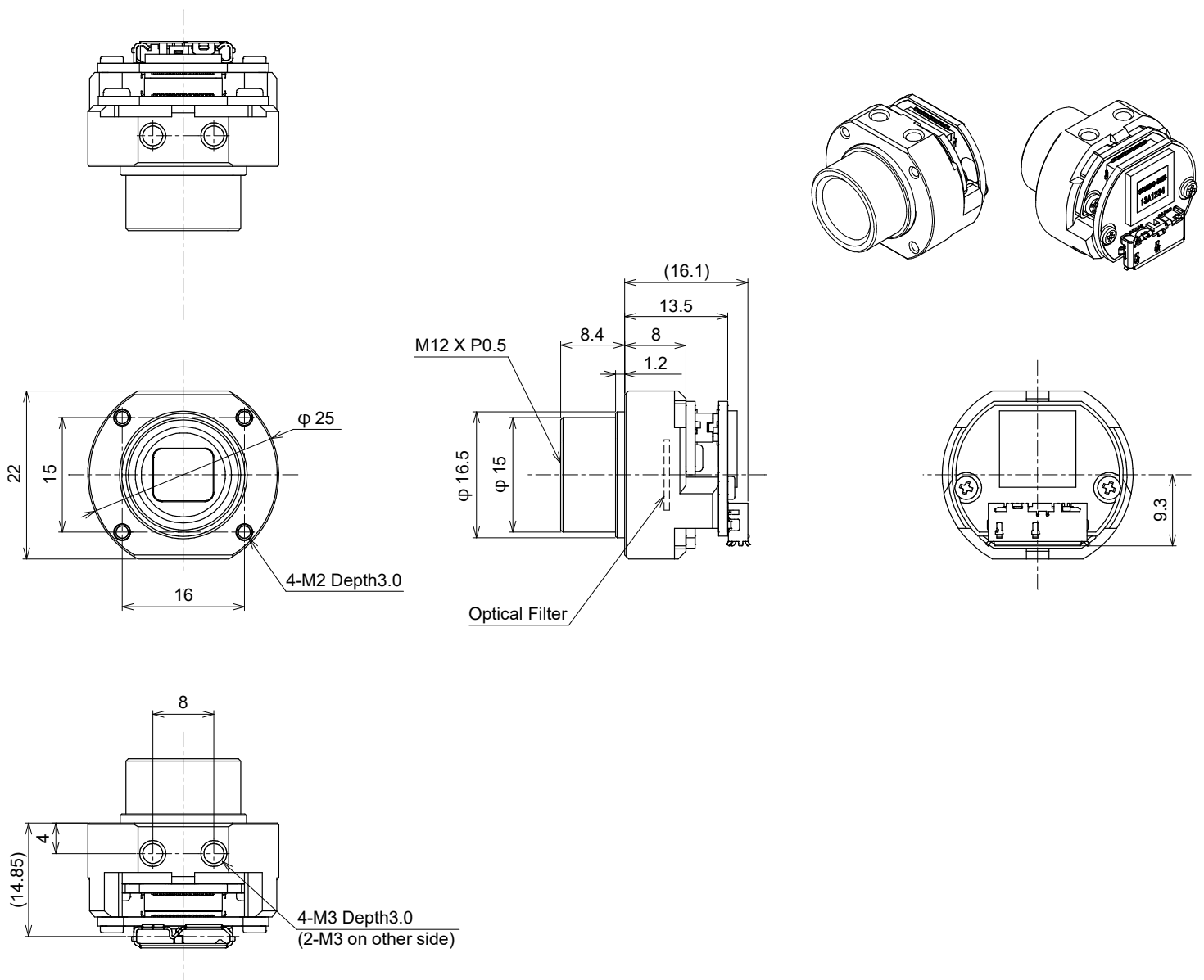

Unit: mm

5.3 STC-S133UVC-BLCS / STC-S133UVC-DBLCS

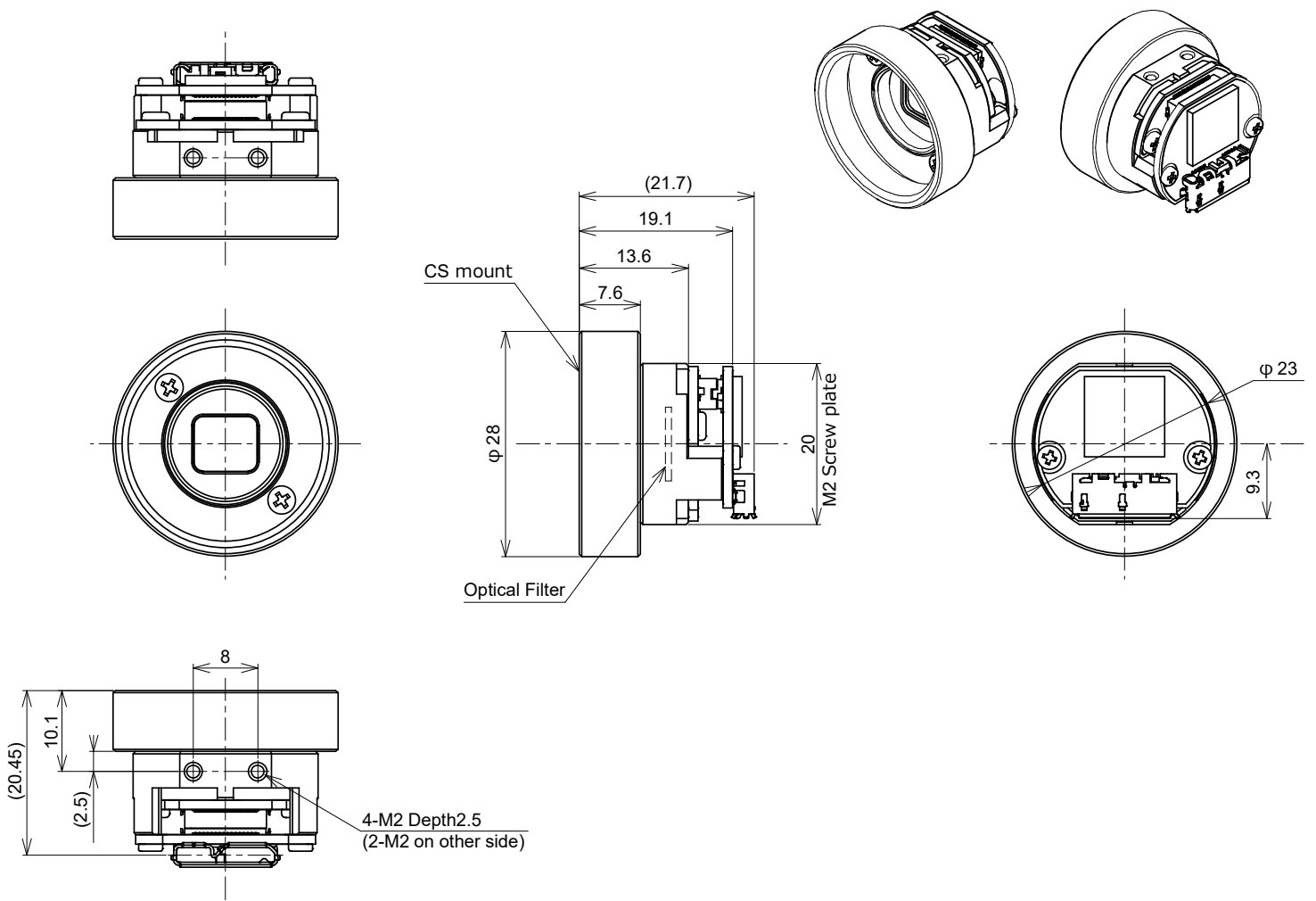

Unit: mm

5.4 STC-S133UVC-ALL / STC-S133UVC-DALL

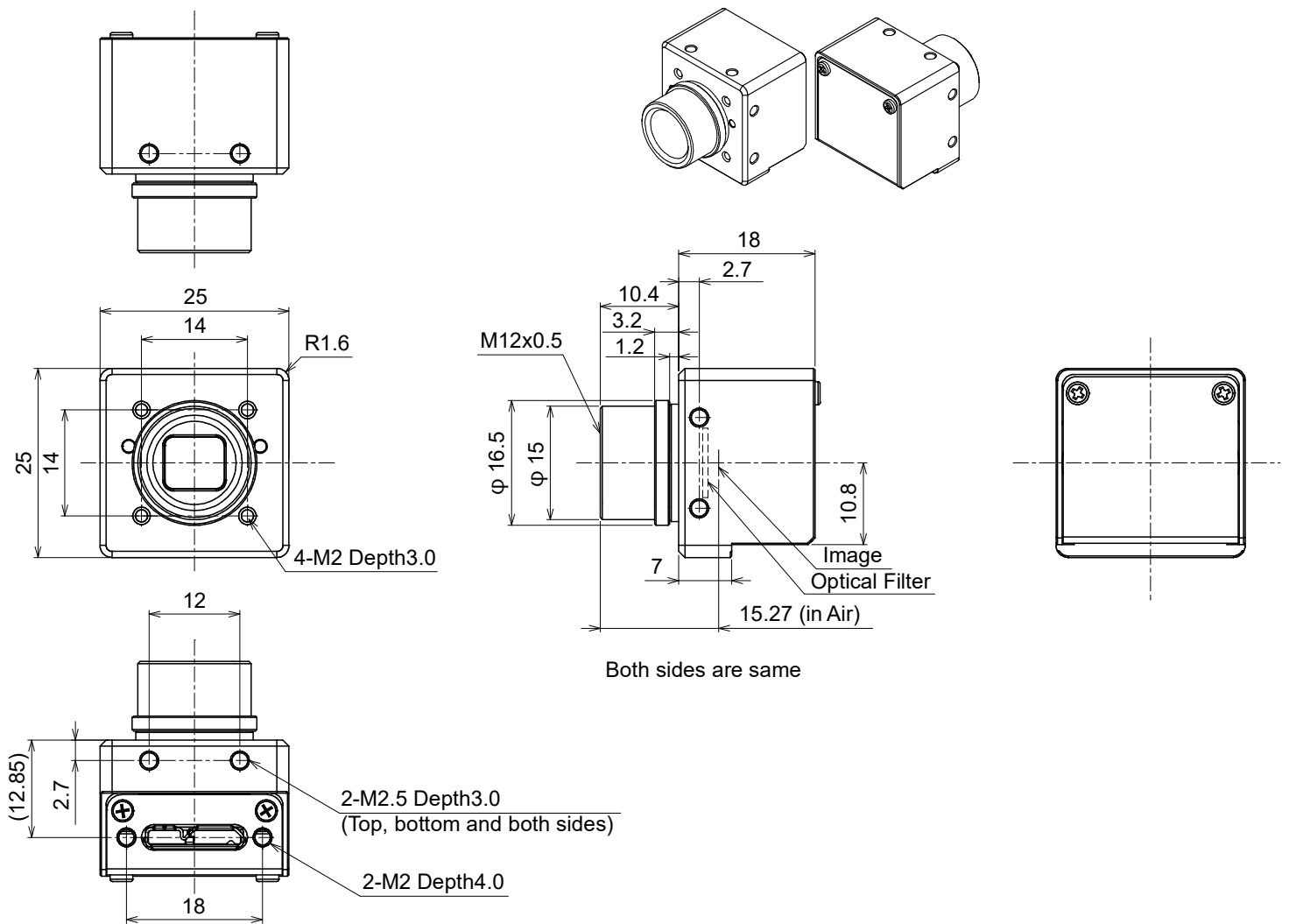

Unit: mm

5.5 STC-S133UVC-ALCS / STC-S133UVC-DALCS

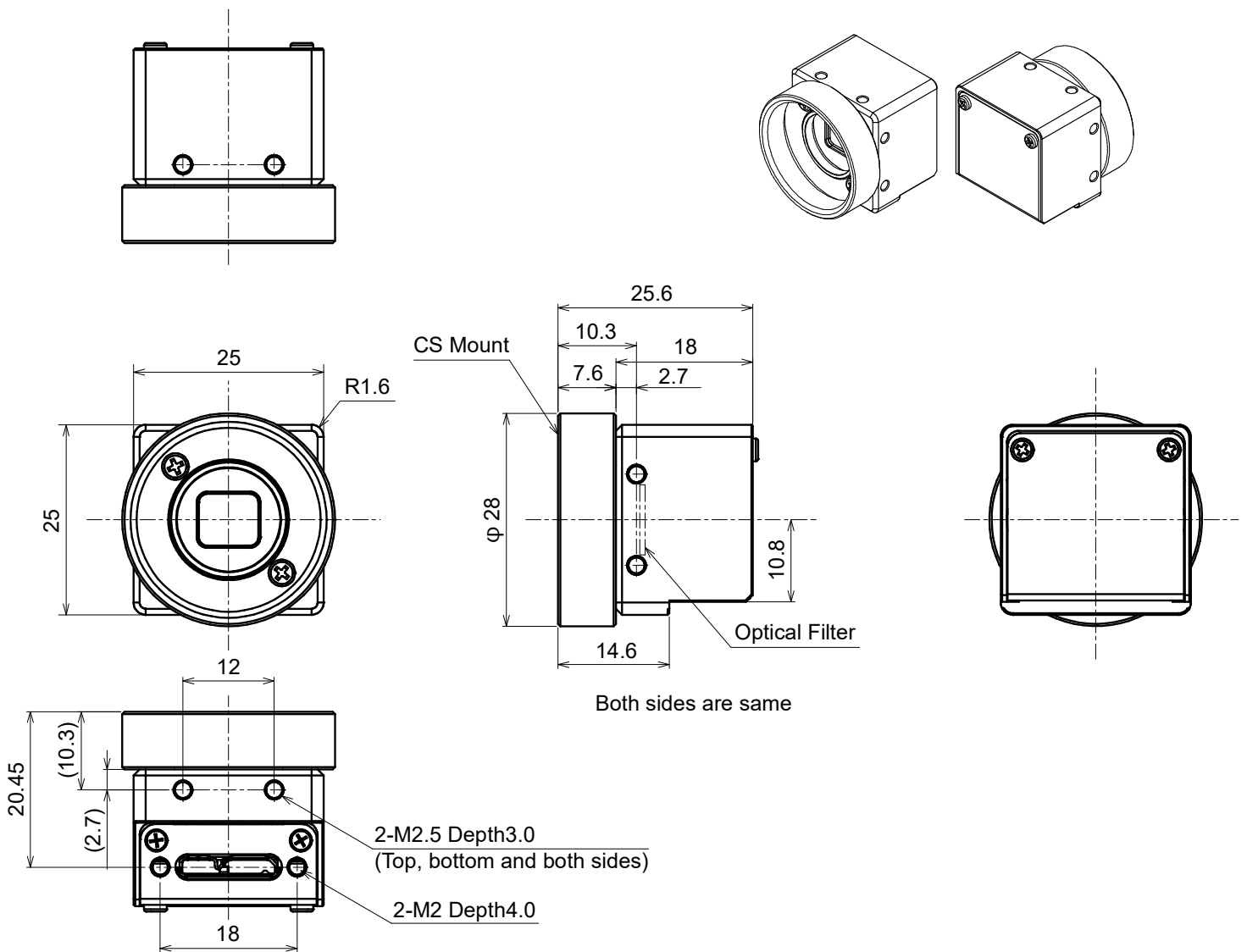

Unit: mm

6 Communication control software users guide

6.1 Requirement software

1) Control software KSACtrl v2.02 or newer

6.2 Connecting configuration

When KSACtrl (v2.02 or newer) is installing, the installation menu for CDC driver is added to the program menu. Please install CDC driver before STC-S133UVC camera connects to the PC.

6.3 Communication settings

UART (RS232C compliant), Binary communication

Setting	Value
Baud rate	115,200 bps
Data bit	8 bits
Parity	None
Stop bit	1 bit
Flow control	None

6.4 Basic operating procedure

The camera communication software (KSACtrl) is usable after install KSACtrl software.

Start KSACtrl software.



Select the COM port number to use the camera communication by selecting “Port Setting” under “Comm (C)” in the menu.

Select “Read All” button to read all of the register information from the camera.

All of the camera settings are configurable through the camera control software.

6.5 The descriptions for the buttons



Read All

Read out all camera settings in the camera. Please select this button every time when the camera power is turning on.

This software stores as the camera default settings in to the Flash memory on the camera when first time select “Read All” button after run KSACtrl software.

* The camera settings are not reflecting as default data from the second time select “Read all” button.

Note.1: It will take time to read out all camera settings while the image streaming.

It will not take long time when reading out the camera settings without the image stream

Note.2: Please read out all camera settings without the image streaming while the camera connects to USB2.0 port.

It is possible to stop freeze the image streaming if read out all camera settings while the image streaming.

DSP -> FLASH

Save the camera settings (changed settings) in to the Flash memory on the camera.

All changed camera settings save to the Flash memory at once.

Reset

N/A

6.6 The descriptions of the functions

Menu

File(F) Comm(C) Mode(M) Help(H)

File(F)

Save As[DSP->File]...

Read the camera settings and creates the camera settings file.

Open[File->DSP]...

Load the camera settings from the camera settings file then apply to the camera.

Open[File->Flash]...

Load the camera settings from the camera settings file then apply to the camera and save the camera settings in to the flash memory.

Comm (C)

Same function as “Read All” and “DSP->Flash” button located in bottom of the software.

Mode (M)

Adjustment

The individual camera settings are adjustable.

One Shot

The camera settings save to the file and load from the camera setting file to the camera.

Shutter/Gain Tab

AE Mode	
Exposure Control Mode [C018_000H]	[00H]AE
Convergence luminance [C018_010H.0-011H.7]	12828
AE convergence speed settings [C018_012H]	216
Frame count for dead band [C018_01CH]	2
Dead band / AE tracking [C018_01DH]	26
Dead band / AE convergence [C018_01EH]	4
EV Correction [C019_09CH]	0

Exposure Control Mode (Default: AE)

AE

The brightness level is adjusting with the shutter and gain automatically.

It is necessary to set the shutter and the gain at "Normal AE" Tab.

HOLD

The shutter and gain are holding. When the brightness of the target is changed, the camera does not adjust the brightness.

Scale ME

The brightness level is adjusting by the shutter and gain settings.

User Preset ME

The brightness level is adjusting by the preset shutter and gain.

Full ME

The brightness level is adjusting the manually by the shutter and gain at "Full ME" Tab.

Convergence luminance

Set the convergence luminance for AE. (Default: 12,828)

AE convergence speed setting

Set the AE convergence speed. When set greater value, the AE convergence speed increases. (Default: 216)

Frame count for dead band

Set the number of the frame that uses for the AE control start judgement. (Default: 2)

Dead band / AE tracking AE

Set the AE convergence stop condition.

AE convergence is stopped when AE error is less than this setting and keeps the same condition more than three frames. (Default: 26)

Dead Band / AE convergence AE

Set the AE convergence start condition.

AE convergence starts when AE error is greater than this setting and keeps the same condition more than the frame counter of the dead band. (Default: 4)

EV correction

Set the amount of the exposure. (Default: 0)

Shutter/Gain

Minimum Shutter time [C019_000H.0-003H.7]	<input type="range"/>	<input type="text" value="1"/>
	<input type="button" value="1/50"/> <input type="button" value="1/60"/> <input type="button" value="1/100"/> <input type="button" value="1/120"/> <input type="button" value="1/200"/> <input type="button" value="1/500"/> <input type="text" value="1.0[us], 1/1000000.0[s]"/>	
Maximum Shutter time [C019_090H.0]	<input type="text" value="[00H]Disable"/>	
Maximum Shutter time [C019_094H.0-097H.7]	<input type="range"/>	<input type="text" value="0"/>
	<input type="button" value="1/50"/> <input type="button" value="1/60"/> <input type="button" value="1/100"/> <input type="button" value="1/120"/> <input type="button" value="1/200"/> <input type="button" value="1/500"/> <input type="text" value="-"/>	
Minimum Gain [C019_004H.0-005H.1]	<input type="range"/>	<input type="text" value="4"/>
		<input type="text" value="0.4[dB]"/>
Maximum Gain [C019_099H.0]	<input type="text" value="[00H]Disable"/>	
Maximum Gain [C019_09AH.0-09BH.1]	<input type="range"/>	<input type="text" value="0"/>
		<input type="text" value="0.0[dB]"/>
Shutter Priority time [C018_008H.0-00BH.7]	<input type="range"/>	<input type="text" value="0"/>
	<input type="button" value="1/50"/> <input type="button" value="1/60"/> <input type="button" value="1/100"/> <input type="button" value="1/120"/> <input type="button" value="1/200"/> <input type="button" value="1/500"/> <input type="text" value="OFF"/>	
Gain Priority Setting [C018_00CH.0-00DH.1]	<input type="range"/>	<input type="text" value="0"/>
		<input type="text" value="OFF"/>

Minimum / Maximum shutter time, Minimum / Maximum Gain

Set the limit for the shutter and gain.

Shutter Priority time

The AE becomes the shutter prioritized AE when setting other than "0" while AE mode.

It is necessary to select the value that between the minimum and maximum shutter time.

The shutter is fixed as the selected shutter time and the brightness level is adjusting by the gain. (Default: 0)

Gain Priority setting

The AE becomes the gain prioritized AE when setting other than "0" while AE mode.

It is necessary to select the value that between the minimum and maximum gain.

The gain is fixed as the selected gain and the brightness level is adjusting by the shutter time. (Default: 0)

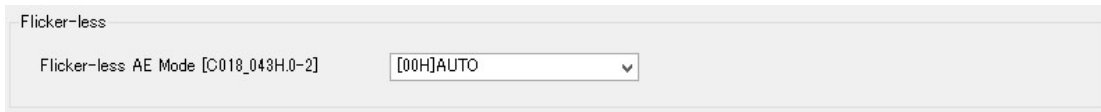

Flicker-less AE Mode (Default: Auto)

Auto

When the power on the camera with auto flicker-less, the default: condition is “OFF” and the function does not work unless detecting the flicker.

The shutter time is adjusting continuously when the flicker less function starting. The flicker-less function is Off when the brightness of image becoming bright from 1/100seconds or 1/120 seconds condition, or the flicker less reset function is on.

50Hz / 60Hz Forced

This mode forces to 50Hz/60Hz flicker less function even does not detect the flicker.

The outdoor detection and the flicker less reset function do not work with this mode.

50Hz / 60Hz Fixed

This mode forces to 50Hz/60Hz flicker less function.

This flicker less function is of when the outdoor detection and the flicker less reset function are working.

OFF

The flicker-less function does not use.

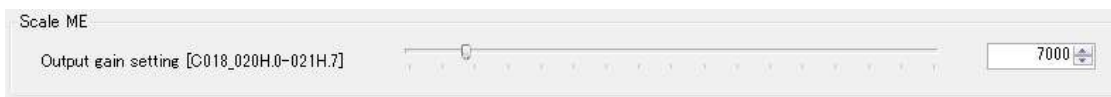

Set the gain for Scale ME mode. (Default: 7,000)



The four sets of shutter and gain for User Preset ME mode are changeable.

The default setting is table in below:.

Preset No.	Preset 0 (Default)	Preset 1	Preset 2	Preset 3
Shutter time	16,666	10,000	15,000	16,666
Gain	0	100	150	200

Lens Tab

The lens compensation settings are selectable in this Tab.

Vignetting and Distortion Compensation	
Vignetting and distortion [C090_000H.0]	[00H]Disable
Vignetting compensation [C090_001H.0]	[00H]Disable
Distortion compensation [C090_00FH.0]	[00H]Disable

Vignetting and distortion

Select "Enable" or "Disable" for the vignetting compensation and distortion compensation functions. Please select "Enable" if the vignetting or distortion compensation function uses. (Default: Disable)

Vignetting compensation

Select "Enable" or "Disable" for the vignetting compensation. (Default: Disable)

Distortion compensation

Select "Enable" or "Disable" for the distortion compensation. (Default: Disable)

Vignetting compensation settings

The vignetting that caused by the lens or housing, is compensating function.

Vignetting	
H. Optical center [C090_002H.0-003H.3]	640
V. Optical center [C090_004H.0-005H.2]	480
Radius [C090_00AH.0-00BH.3]	640
Ellipticity [C090_008H.0-009H.7]	32768

H. Optical center / V. Optical center

Set the optical horizontal and vertical center position. (default: Horizontal: 640, Vertical: 480)

Radius

Set the compensation radius from the optical center position. (Default: 640)

Ellipticity

Set the ellipticity ratio. (Default: 32,768)

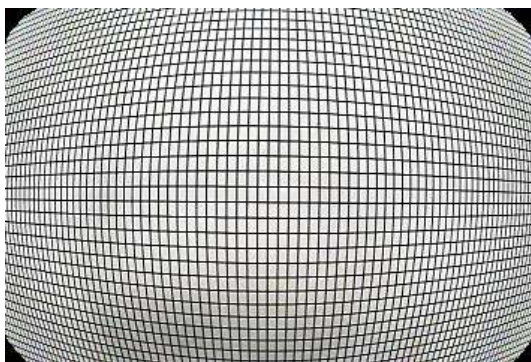

Vegnetting compensation Off

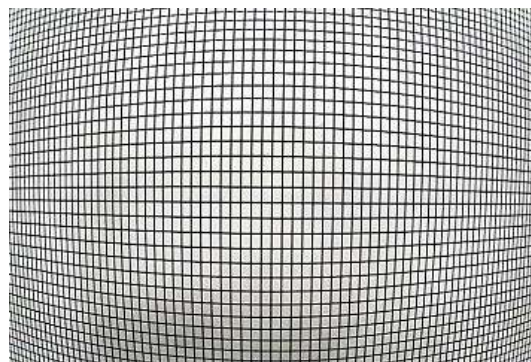

Vegnetting compensation On

Distortion compensation settings

Distortion

Distortion KNOT AB select [C090_010H.0] [01H]B

Distortion KNOT CD select [C090_010H.1] [01H]D

A/B/C/D mixed ratio [C090_012H.0-013H.0] 0

A/B/C/D mixed ratio [C090_014H.0-015H.0] 256

KNOT A | KNOT B | KNOT C | KNOT D

Distortion Comp. A K0 [C090_016H.0-017H.2]	804
Distortion Comp. A K1 [C090_018H.0-019H.2]	804
Distortion Comp. A K2 [C090_01AH.0-01BH.2]	807
Distortion Comp. A K3 [C090_01CH.0-01DH.2]	814
Distortion Comp. A K4 [C090_01EH.0-01FH.2]	824
Distortion Comp. A K5 [C090_020H.0-021H.2]	838
Distortion Comp. A K6 [C090_022H.0-023H.2]	857
Distortion Comp. A K7 [C090_024H.0-025H.2]	881
Distortion Comp. A K8 [C090_026H.0-027H.2]	911
Distortion Comp. A K9 [C090_028H.0-029H.2]	948
Distortion Comp. A K10 [C090_02AH.0-02BH.2]	994
Distortion Comp. A K11 [C090_02CH.0-02DH.2]	1053
Distortion Comp. A K12 [C090_02EH.0-02FH.2]	1111
Distortion Comp. A K13 [C090_030H.0-031H.2]	1169

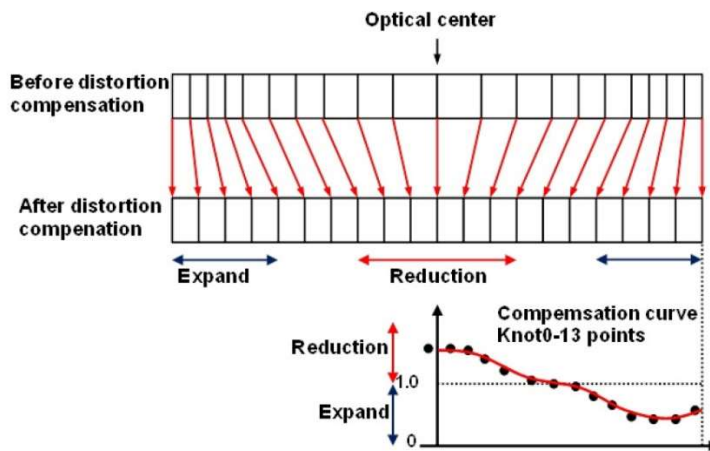

KNOT K0 (optical center) to KNOT K13 (edge) are the compensation points for the distortion compensation. When set the greater value, the distortion is reduced. When set the smaller value, the distortion is extended. There are four types (A, B, C and D) of the compensation points are available.

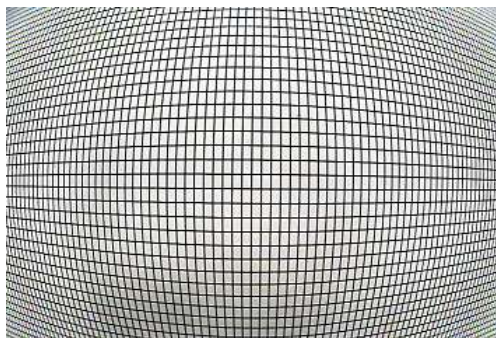

Distortion compensation OFF

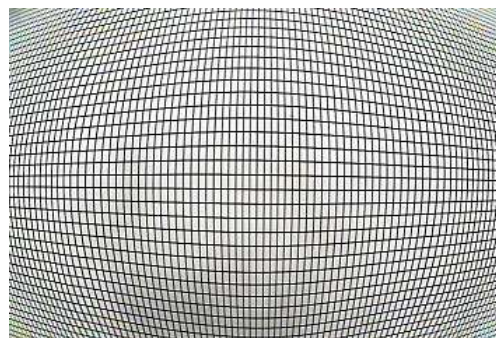

Distortion compensation ON

OSD Tab

OSD settings are selectable in this Tab. OSD is available when the resolution is 1,280 x 720 or 1,280 x 900.

Control

Menu Up [C002_018H.0-1]	[02H]ON	
Menu Down [C002_078H.0-1]	[02H]ON	
Menu Left [C002_048H.0-1]	[02H]ON	
Menu Right [C002_058H.0-1]	[02H]ON	
Menu Enter [C002_030H.0-1]	[02H]ON	

The OSD is usable with “Up”, “Down”, “Left”, “Right” and “Enter” buttons.

Horizontal start position [C100_0D6H.0-0D7H.1]		26
Vertical start position [C100_0D8H.0-0D9H.1]		14
OSD Time out setting [C100_064H]		0

Save button

Save the OSD horizontal and vertical start position for the OSD parameter load is valid.

Note. The OSD horizontal and vertical start position cannot save by “DSP->FLASH” button when the OSD parameter load is valid. It is necessary to use “Save” button to save the OSD horizontal and vertical start position.

OSD horizontal start position, vertical start position

Set the OSD horizontal and vertical start position (display position).

OSD Time out setting

Set the time out setting for the OSD with second unit.

This function is invalid when setting 0.

Cursor, character and character edge settings

Cursor

Cursor blend ratio [C100_0DCH.0-1] [03H]100%(Non-transparent) ▾

Cursor Brightness [C100_0DCH.4-7] 4 ▾

CursorCb [C100_0DDH.0-3] 8 ▾

CursorCr [C100_0DDH.4-7] 8 ▾

Character

Character blend ratio [C100_0DEH.0-1] [03H]100%(Non-transparent) ▾

Character Brightness [C100_0DEH.4-7] 15 ▾

CharacterCb [C100_0DFH.0-3] 8 ▾

OSD CharacterCr [C100_0DFH.4-7] 8 ▾

Character edge

Character edge blend ratio [C100_0E0H.0-1] [03H]100%(Non-transparent) ▾

Character edge Brightness [C100_0E0H.4-7] 0 ▾

Character edgeCb [C100_0E1H.0-3] 8 ▾

Character edgeCr [C100_0E1H.4-7] 8 ▾

Character edge [C100_0E2H.0] [01H]ON ▾

Cursor blend ratio / Character blend ratio

Set the transparent ratio for the cursor and character of the OSD.

Cursor Brightness / Character Brightness

Set the brightness for the cursor and character of the OSD.

Cursor Cb / Cursor Cr / Character Cb / Character Cr

Set the color (Cb and Cr) for cursor and character of the OSD.

Character edge

Set "Enable" or "Disable" for the character humming

The default color for cursor, character and character edge are in below table.

OSD	Y	Cr	Cb	Blend	Notes (color)
Cursor	4 [h]	8 [h]	8 [h]	3 [h]	Gray
Character	F [h]	8 [h]	8 [h]	3 [h]	White
Character humming	0 [h]	8 [h]	8 [h]	3 [h]	Black

WDR Tab

The image is composed with two or three different shutter time images to compensate the clipped white image and crushed shadow image.

WDR	
Wide Dynamic Range [C:020_000H.0-1]	[00H]AUTO
WD exposure ratio fix [C:020_0A4H.0]	[00H]OFF
Max. WD exposure ratio [C:020_004H.0-005H.7]	2048
ATR_EX function [C:033_000H.4]	[01H]ON
ATR_EX contrast gain [C:033_004H.0-005H.0]	128
ATR_EX brightness comp. [C:033_006H.0-007H.0]	128

Wide Dynamic Range (Default: Auto)

Auto: WDR exposure and long exposure switch automatically for the object condition.

WDR fixed when select "Long exposure fixed" while selecting User Preset ME

Long Exposure fixed: Fixed as the long exposure.

WD exposure ratio fix (Default: Off) / Max. WD exposure ratio (Default: 2,048)

Set the exposure ratio for WDR.

ATR-EX function (Default: On) / ATR-EX contrast gain (Default: 128) / ATR-EX brightness comp (Default: 128)

ART-EX function is improved the visibility based on the brightness information.

Defog

Defog	
Defog [C:073_082H.0-1]	[00H]OFF
Defog "ON" frame [C:073_07EH.0-07FH.7]	2
Defog "OFF" frame [C:073_080H.0-081H.7]	0
DEFOG strength [C:055_032H.0-1]	[01H]Mid
DEFOG sensitivity [C:055_033H.0-1]	[01H]Mid

Defog function is improved the visibility with emphasis the contrast and color saturation for the fogged image.

When selecting "Auto" for Defog, the response sensitivity is adjusting with the number of the frame for On and OFF.

High Luminance Compensation (HLC)

The high luminance compensation function is improved the visibility for the license plate under the dark condition with the strong light (like headlights), with suppression and mask process.

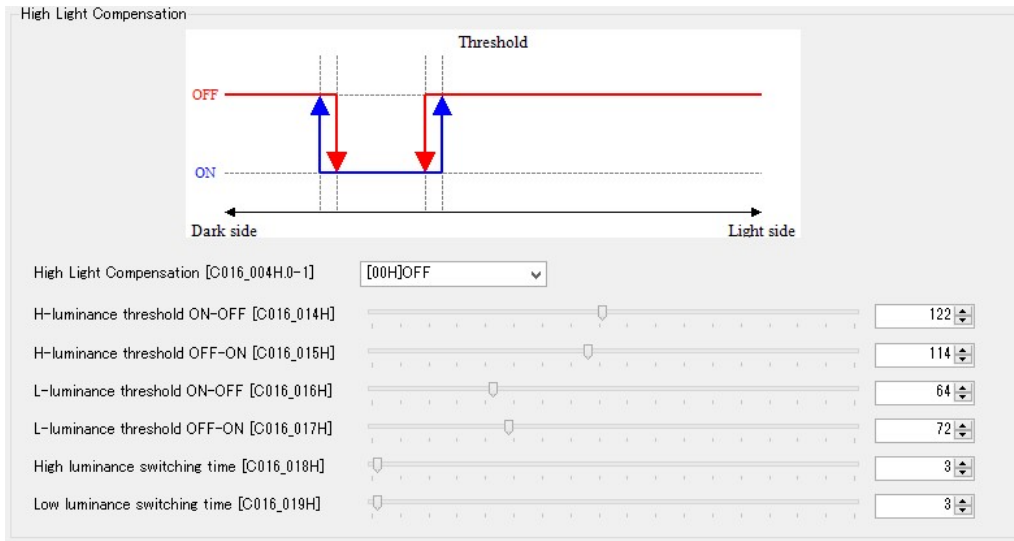

- H-luminance threshold ON-OFF
- H-luminance threshold OFF-ON
- L-luminance threshold ON-OFF
- L-luminance threshold OFF-ON
- High luminance switching time
- Low luminance switching time

- Set the threshold for high luminance compensation from ON to OFF
- Set the threshold for high luminance compensation from OFF to ON
- Set the threshold for low luminance compensation from ON to OFF
- Set the threshold for low luminance compensation from OFF to ON
- Set the switching time (unit second) for high luminance compensation
- Set the switching time (unit second) for low luminance compensation

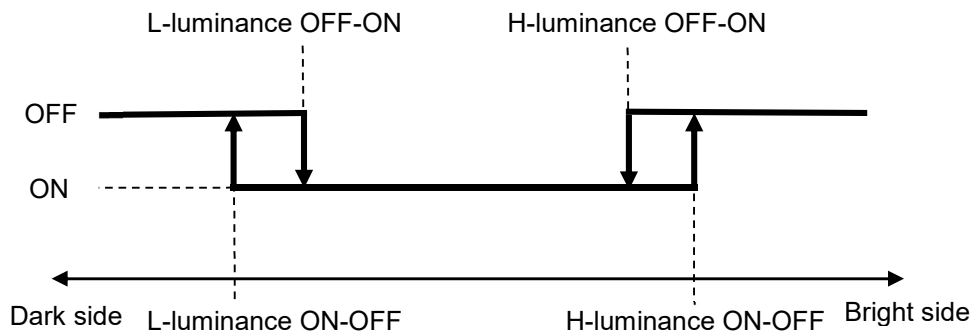

It is necessary to set L-luminance ON-OFF < L-luminance OFF-ON < H-luminance OFF-ON < H-luminance On-OFF.

AE Weight Tab

AE Weight

Photometry Mode [C016_002H.0-1] [00H]Average ▾

Center weight photometry

2	4	6	8	10	8	6	4	2
6	12	18	25	30	25	18	12	6
25	40	50	70	80	70	50	40	25
50	60	80	90	100	90	80	60	50
15	20	25	40	60	40	25	20	15
6	12	18	25	30	25	18	12	6
2	4	6	8	10	8	6	4	2

00~08 frames 2 ▾ 4 ▾ 6 ▾ 8 ▾ 10 ▾ 8 ▾ 6 ▾ 4 ▾ 2 ▾

09~17 frames 6 ▾ 12 ▾ 18 ▾ 25 ▾ 30 ▾ 25 ▾ 18 ▾ 12 ▾ 6 ▾

18~26 frames 25 ▾ 40 ▾ 50 ▾ 70 ▾ 80 ▾ 70 ▾ 50 ▾ 40 ▾ 25 ▾

27~35frames 50 ▾ 60 ▾ 80 ▾ 90 ▾ 100 ▾ 90 ▾ 80 ▾ 60 ▾ 50 ▾

36~44 frames 15 ▾ 20 ▾ 25 ▾ 40 ▾ 60 ▾ 40 ▾ 25 ▾ 20 ▾ 15 ▾

45~53 frames 6 ▾ 12 ▾ 18 ▾ 25 ▾ 30 ▾ 25 ▾ 18 ▾ 12 ▾ 6 ▾

54~62 frames 2 ▾ 4 ▾ 6 ▾ 8 ▾ 10 ▾ 8 ▾ 6 ▾ 4 ▾ 2 ▾

Spot photometry

0	1	2	3	4	5	6	7	8
9	10	11	12	13	14	15	16	17
18	19	20	21	22	23	24	25	26
27	28	29	30	31	32	33	34	35
36	37	38	39	40	41	42	43	44
45	46	47	48	49	50	51	52	53
54	55	56	57	58	59	60	61	62

Center spot frame number [C018_003H]

Weight coefficient surrounding frame [C018_004H]

Photometry mode

It is possible to keep the brightness level or the specific image are by adjusting the weight of the histogram for the area or the brightness. The photometry mode is selectable from “Average”, “Center”, “Spot” and “Histogram”.

The average brightness of the full image uses for the average photometry mode.

The weighted brightness of 63 areas (7x9 areas) uses for the center photometry mode.

The weighted brightness of surround frame of the target frame uses for the spot photometry mode.

Normal AE Tab

Set the shutter and gain for the normal AE mode.

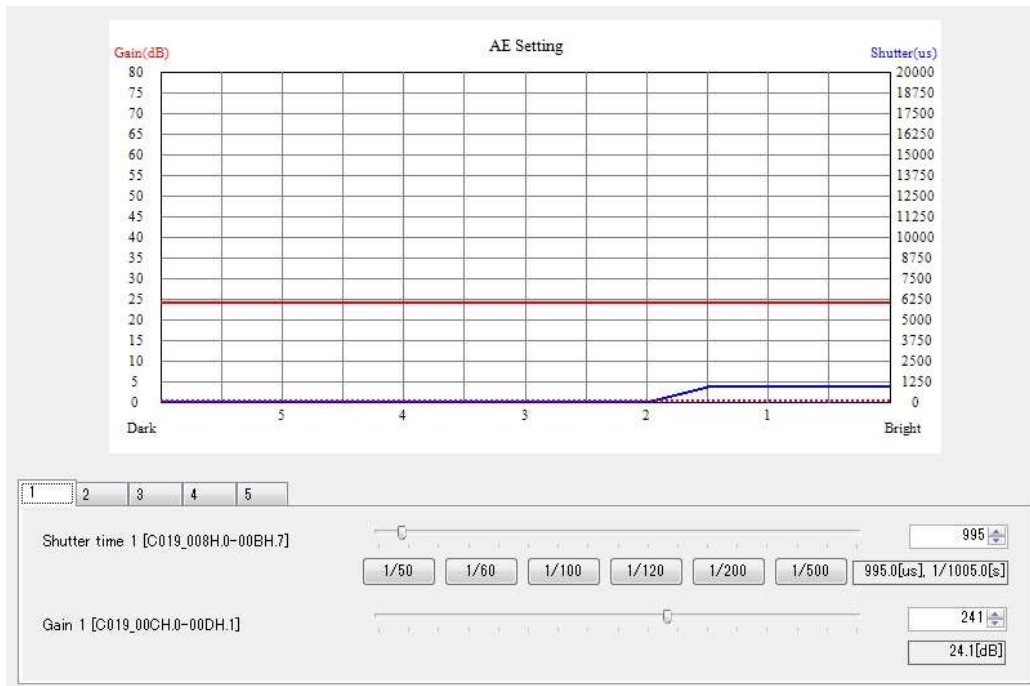

5 steps control range for the shutter and gain is selectable for Normal AE.

Please set from 1 (Bright) to 5 (Dark).

Please set with the monotonous increment.

The default settings for the shutter and gain for 5 steps control are in below table.

Step	1	2	3	4	5
Exposure time	1	1	1	20,000	20,000
Gain	0	0	0	0	241

Full ME Tab

Set the shutter and gain for the full ME AE mode.

Full ME

Shutter (long exposure) [C018_180H.0-183H.7]

Shutter(short exposure1) [C018_188H.0-18BH.7]

Shutter(short exposure2) [C018_190H.0-193H.7]

Gain (long exposure) [C018_196H.0-197H.1]

Gain(short exposure1) [C018_198H.0-199H.1]

Gain(short exposure2) [C018_19AH.0-19BH.1]

ISP Gain [C018_19CH.0-19DH.1]

WDR exposure mode [C018_19FH.0]

Conversion gain [C018_1A0H.0]

Set the shutter speed and gain for the long exposure, short exposure 1 and short exposure 2.

AE Mask Tab

Set the mask frame for AE frame detection.

Set mask frame is excluding frame for AE detection.

The mask frame can set up to 16 frames.

In case of the image has vignetting, the optimized brightness of the image can keep it by excluding the vignetting area for AE detection.

(0,0) OPD (1280,0)

(0,600) (1280,600)

Mask 0 Mask 1 Mask 2 Mask 3 Mask 4 Mask 5 Mask 6 Mask 7 Mask 8 Mask 9 Mask 10 Mask 11 Mask 12 Mask 13 Mask 14 Mask 15

AE OPD Mask 0 [C097_000H.0] [00H]OFF

Mask 0 H. start position [C097_002H.0-003H.3] 0

Mask 0 H. end position [C097_004H.0-005H.3] 0

Mask 0 V. start position [C097_006H.0-007H.2] 0

Mask 0 V. end position [C097_008H.0-009H.2] 0

WhiteBalance Tab

Control	Push Lock pin [C002_050H.0-1]	[00H]OFF
---------	-------------------------------	----------

Push lock pin

N/A

White Balance	
White Balance Mode [C036_000H]	[00H]ATW Push Lock
ATW pull-in speed [C036_007H]	<input type="range"/> 1
MWB operation [C036_009H]	<input type="range"/> 41
ATW indoor / outdoor mode [C036_01AH]	[00H]Indoor
Indoor ATW step near [C036_04DH]	<input type="range"/> 16
Indoor ATW step near outside [C036_04EH]	<input type="range"/> 2
Outdoor ATW step near [C036_04FH]	<input type="range"/> 2
Outdoor ATW step near outside [C036_050H]	<input type="range"/> 2
ATW pull-in delay frame [C036_055H]	<input type="range"/> 8
All Pull-in Convergence Step [C036_05BH]	<input type="range"/> 2

White balance mode

ATW mode

The white balance control automatically with the indoor/outdoor judgement and estimate the light source.

ATW mode is less inference for the color saturated target.

All pull in mode

The white balance control automatically without dependence of the indoor/outdoor light source.

The wide range color pull into the white.

This mode re-adjust the white balance by inference for the color saturated target.

Hold mode

Hold the white balance gain and stop AWB operation.

Saved white balance gain is applied when power on the camera with the hold mode.

MWB mode

The white balance control with the specific color temperature.

User mode

5 sets of the R and B gain are selectable.

OnePush mode

The white balance control automatically by the all pull in then hold the white balance gain and stop the white balance control.

Push Lock button

The white balance control automatically then hold the white balance gain and stop the white balance control.

MWB operation

Set the color temperature for MWB mode.

ATW indoor/outdoor mode

Pull in frame for the indoor and outdoor are selectable.

Pull in the blue sky then suppress red at Outdoor (blue sky) mode.

Other settings

Set the sensitivity for ATW mode and all pull in mode.

White Balance Offset

White balance offset [C036_006H.4] [00H]OFF

White balance offset R/G [C036_06EH.0-06FH.7] 0

White balance offset B/G [C036_070H.0-071H.7] 0

White balance offset

This function is shifting the convergence point by adding the offset. This function is useful when keep the color.

User Mode

User mode [C036_00AH] [00H]5800K

Mode 0 Mode 1 Mode 2 Mode 3 Mode 4

Mode 0 R/G [C041_000H.0-001H.7] 3072

Mode 0 B/G [C041_002H.0-003H.7] 6144

User mode

Five different use modes are available.

The default setting for five user modes are in below table.

User mode0	Fine weather (shade)	5,800 K
User mode1	Fluorescent light	4,100 K
User mode2	Cloudy weather	6,500 K
User mode3	Halogen light	3,200 K
User mode4	Incandescent light	2,900 K

The default R/G and B/G for each user mode are in below table.

設定番号	mode0	mode1	mode2	mode3	mode4
R/G	3,072	3,328	2,878	4,089	4,321
B/G	6,144	4,096	6,657	4,093	3,629

Please follow below procedure to adjust the user mode white balance under the specific light condition

Select all pull in mode with the white target.

Read CONT_R and CONT_B after select "Read" button.

Set value of CONT_R to modex R/G and value of CONT_B to modex B/G. (x 0 to 4 mode number)

Other

CONT_R (Read Only) CONT_B (Read Only)

Gamma Tab



Gamma offset

Add the offset for the gamma curve. When set the greater offset, the output for the preset point become smaller.

Gamma through

Set the through or magnification for the input data.

Gamma preset (manual gamma)

27 points adjustment is available for the manual gamma.



Black compensation

This function is improved the image by the adjusting the low brightness level.

Chroma Tab

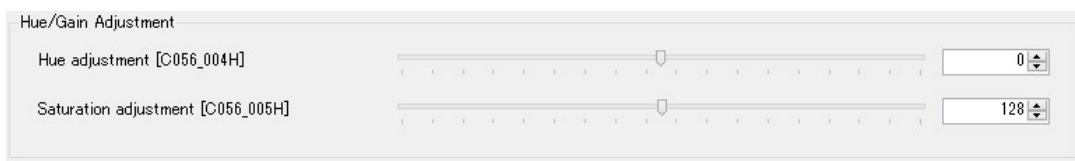

Hue adjustment

Hue is the center adjustment position when set 0[h].

When set 1[h] to 5A[h], the hue changes with the clockwise rotation. When set FF[h] to A6[h], the hue changes with the counter clockwise rotation. The unit is 1deg. / step.

Saturation adjustment

Saturation is the center adjustment position when set 80[h].

When decreases from 80[h] to 0[h], the image becomes low saturation image. When increases from 80[h] to FF[h], the image becomes high saturation image.

0[h] x0 saturation, 80[h] x1 saturation, FF[h] x2 saturation

Other Tab

UART	UART baud rate [C001_011H.0-2]	[06H]115200bps
------	--------------------------------	----------------

UART

Changed baud rate is enabled when restart the camera after save the baud rate setting to the flash memory on the camera by selecting "DSP->FLASH" button.

Mirror/Flip	Horizontal inversion [C001_016H.0]	[00H]OFF	Vertical inversion [C001_016H.1]	[00H]OFF
-------------	------------------------------------	----------	----------------------------------	----------

Mirror/Flip

Set the image output with the horizontal flip, vertical flip or horizontal and vertical flip.

Picture	Sharpness [C056_000H]		64
	Contrast [C056_001H]		128
	Brightness [C056_002H.0-003H.7]		0
	Negative-positive settings [C082_010H.0]	[00H]OFF	
	Pattern Generator [C057_006H.0-2]	[00H]OFF	

Sharpness / Contrast / Brightness / Negative-positive

Adjust each setting for the image.

Pattern Generator

Select the test pattern output.

Noise Reduction	Brightness Y-NR [C056_006H]		16
	Pixel correlation Y-NR [C056_007H]		16
	Horizontal C-NR [C056_008H]		16
	Vertical 3Line C-NR [C056_009H]		16
	Vertical IIR C-NR [C056_00AH]		16
	Vertical IIR C-NR [C056_00BH]		16
	Vertical IIR C-NR [C056_00CH]		16

Noise reduction

Brightness Y-NR

This function keeps the edge component for the middle component of the brightness and the noise reduces at less edge component.

Pixel correlation Y-NR

Pixel correlation Y-NR uses 9x9 next same color pixel and subtracts the same color pixel between the target pixel and around pixel.

Check the subtract with the threshold then the subtract is greater than the threshold then apply the average add to reduce the noise.

Pixel correlation Y-NR function is good function for reduce the noise on the human skin.

Horizontal C-NR

The edge component keeps when the brightness is changed. If the brightness does not change, the noise is strongly reduce at similarity area.

Vertical 3Line C-NR

The noise reduces by the flatten process for the microscopic chroma change of the vertical direction.

Vertical IIR C-NR

Observes the vertical direction pixels then control the color gap of the vertical direction.

Privacy Mask Tab

Set the privacy mask setting. Up to 16 frames are available.

Mosaicing horizontal width / vertical width

Set the mosaicing width when the mosaicing mask is enabled.

The unit for the horizontal width is an even number of the pixels and the 1 line for the vertical width.

Mask x

Select On/Off for the mask.

Mask x frame width

Set the frame width of the frame for the mask if it is necessary.

When set 0, the frame does not display.

Mask x mosaicing

Select On/Off for the mosaicing mask.

Mask x Y / Cb / Cr blend data, Y / Cb / Cr blend rate

Set the brightness and color for the mask.

Examples

Y blend rate	Cb/Cr blend rate	Y blend data	Display color
1.0 3[h]	1.0 3[h]	F[h]	White
1.0 3[h]	1.0 3[h]	0[h]	Black

Mask x H. start position / h. end position / v. start position / v. end position

Set the mask display position.

Mask * Gate

When set on this, the masking area is excluding from the AE detection.

Note) The smaller mask number has the priority for mask display.

Day&Night Tab

Set the Day & Night function.

Day/Night [C016_000H.0]	[01H]MANUAL	▼
Manual Mode [C016_000H.1]	[00H]Day	▼
Counter unit [C016_008H.0]	[01H]second	▼
Day/Night Threshold dark side [C016_006H]	<input type="text" value="0"/>	
Day/Night hreshold light side [C016_007H]	<input type="text" value="1"/>	
Day to Night judgement time [C016_00AH.0-00BF]	<input type="text" value="128"/>	
Night to Day judgement time [C016_00CH.0-00DF]	<input type="text" value="128"/>	
IR optimizer [C001_017H.0]	[00H]OFF	▼
Photometry Mode [C016_002H.0-1]	[00H]Average	▼

Day&Night

The camera switches automatically based on AE status when set "AUTO"

Manual Mode

Day or Night mode is selectable when selecting "MANUAL" at Day&Night.

Counter unit

Select the unit of the judgement time (frame or second)

Day/Night Threshold dark side / threshold light side

Set the threshold for the auto Day/Night.

It is necessary to set the dark side < light side.

The image hunching may occur when the difference of threshold for dark side and light side is too small.

Day to Night/Night to Day judgement time

Set the judgement time for switching the mode. The unit for the judgement time is set unit at counter unit.

IR optimizer

This function set the optimize exposure for the IR light under the dark condition.

IR photometry mode

This function is enabled when the IR optimize is enabled.

Please check the "AE weight" for the photometry mode operation.

Read

Read camera's brightness and show on the chart, show the status of Day/Night mode

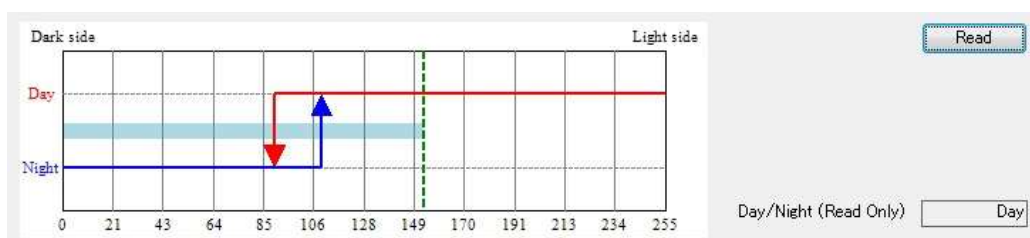

Aperture Tab

Set the enhancement settings for the edge of the image.

1/2fs Aperture Gain		
1/2fs H. aperture gain [C067_005H]		0
1/2fs V. aperture gain [C067_009H]		32
1/2fs oblique aperture gain [C067_00DH]		32
1/4fs Aperture Gain		
1/4fs H. aperture gain [C067_011H]		0
1/4fs V. aperture gain [C067_015H]		32
1/4fs oblique aperture gain D [C067_019H]		32

Set the horizontal, vertical and oblique aperture gain for 1/2fs (high frequency) and 1/4fs (low frequency).
When setting 40[h], enhancement gain is x1.

Analog Tab

Output	
Camera Type	<input type="text"/>
Monochromatic output [C093_000H.6]	[00H]OFF
Mute [C093_000H.0]	[00H]OFF
Y LPF [C093_00BH.0-2]	[01H]x0.25
C LPF [C093_00CH.0]	[00H]Disable

N/A

Blemish Pixel Tab

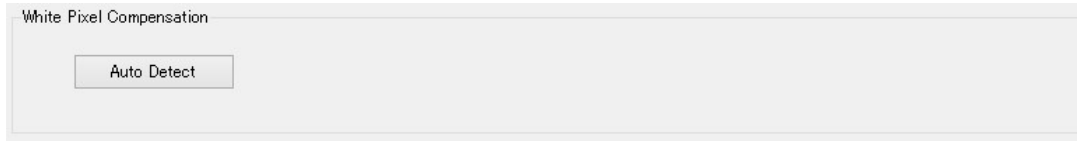

When selecting “Auto Detect” button, the white pixel compensates automatically.

It is necessary to shade the camera before using this function.

Note If the auto detects fails due to the too bright (not shading the camera), saved compensated values are cleared.

Info. Tab

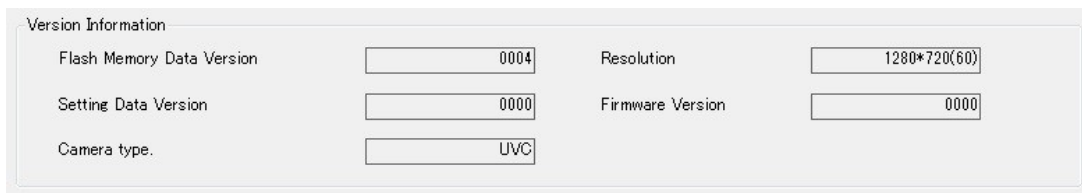

Flash Memory Data Version, Setting Data Version

Display the flash memory data version on the camera.

Camera type

Display the camera type.

Resolution

Display the current resolution.

Firmware Version

Display the firmware version for camera.

Field Table

ShutterGain Tab Page Filter Different Filter

TabPage	Address	Name	Initial	Register
NormalAE	C019_008H.0-00BH.7	Shutter time 1	995	995
NormalAE	C019_00CH.0-00DH.1	Gain 1	340	340
NormalAE	C019_010H.0-013H.7	Shutter time 2	1	1
NormalAE	C019_014H.0-015H.1	Gain 2	540	540
NormalAE	C019_018H.0-01BH.7	Shutter time 3	1	1
NormalAE	C019_01CH.0-01DH.1	Gain 3	540	540
NormalAE	C019_020H.0-023H.7	Shutter time 4	1	1
NormalAE	C019_024H.0-025H.1	Gain 4	540	540
NormalAE	C019_028H.0-02BH.7	Shutter time 5	1	1
NormalAE	C019_02CH.0-02DH.1	Gain 5	540	540
ShutterGain	C018_000H	Exposure Control Mode	[00H]AE	[00H]AE
ShutterGain	C018_001H.0-1	User Preset ME Preset No.	[00H]0	[00H]0
ShutterGain	C018_008H.0-00BH.7	Shutter Priority time	0	0
ShutterGain	C018_00CH.0-00DH.1	Gain Priority Setting	0	0

Display the list of the settings.

Initial is first time read out data after the control software started.

7 Camera setting by the OSD

This camera can change the camera settings by the On Screen Display with camera control software (S133Control).

7.1 OSD operation by camera control software

A. Please check the 4-6. OSD tab descriptions for details of the operation.

Note.

OSD operation is only available with 1,280 x 720 or 1,280 x 960 resolutions

Other resolutions and when camera connecting to USB2.0 port, OSD operation is not available.

7.1.1 OSD menu

SETUP MENU

Page 1



SHUTTER/AGC	Shutter/ Gain Setting (Default: AUTO)
WHITE BAL	White Balance Setting (Default: ATW)
BACKLIGHT	Back Light Compensation (Default: OFF)
PICT ADJUST	Image Processing Setting
DEFOG	Defog Function (Default: OFF)
WDR/ATR	WDR/ATR Setting (Default: WDR and ATR ON)

Page 2

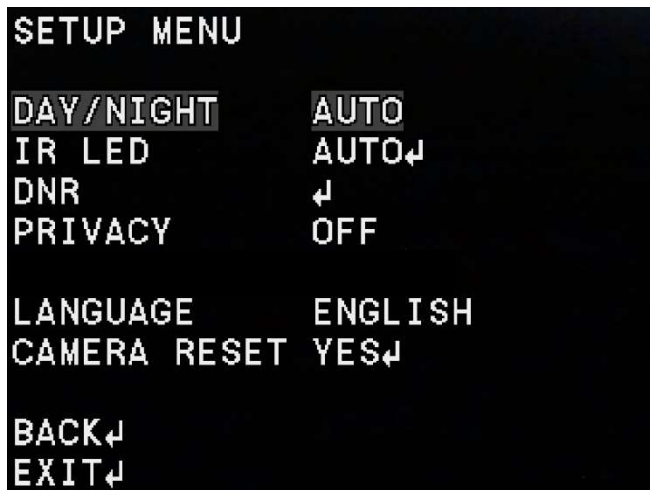

DAT/NIGHT	Day Night Setting (Default: AUTO fixed)
IR LED	No Function
DNR	Noise Reduction Setting (Default: ON)
PRIVACY	Privacy Mask (Default: OFF)
LANGUAGE	OSD Language (Default: ENGLISH)
CAMERA REST	Reset Camera settings

SHUTTER/AGC

1) AUTO SETUP

Setup the AE (Auto Exposure) settings

When selecting "ENTER" after select "AUTO" at "SHUTTER/AGC", AE settings are selectable.

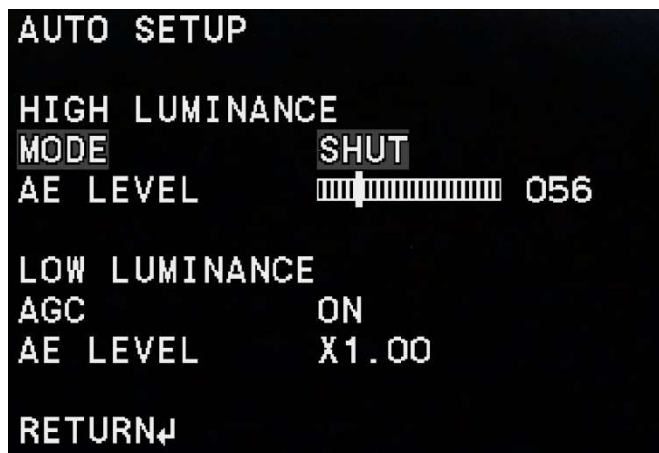

HIGH LUMINANCE

MODE SHUT

Fixed shutter

AE LEVEL

Set the target brightness level for AE (Default:56)

LOW LUMINANCE

AGC

Select AGC mode (ON/OFF) (Default: ON)

AE LEVEL

Set the target brightness level for AE (AGC) (Default: X1.00)

2) MANUAL SETUP

Set up the ME (Manual Exposure) settings

When selecting "ENTER" after select "MANUAL" at "SHUTTER/AGC", ME settings are selectable.

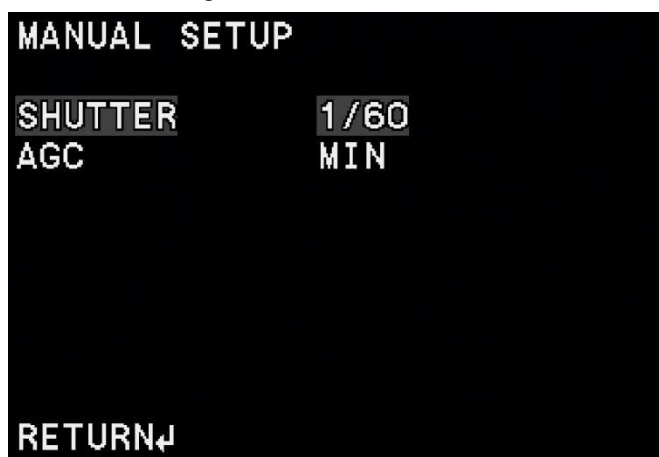

SHUTTER

Select shutter speed (Default: 1/60)

AGC

Set the gain (Default: MIN Gain 0)

WHITE BAL

ATW Auto White balance mode

When selecting "ENTER" after select "AUTO" at "WHITE BAL", ATW settings are selectable.



SPEED	Set pull in speed for ATW (Default: 128)
DELAY CNT	Set delay time for ATW (Default: 8)
ATW FRAME	Select pull in frame for INDOOR/OUTDOOR
ENVIRONMENT	Select pull in frame for ATW (Default: INDOOR)
INDOOR Indoor	(Default: X1.00)
OUTDOOR Outdoor	(Default: X1.00)
AUTO1/2 Indoor / outdoor switch automatically (1 and 2 are sensitivity different mode)	

PUSH All pull in white balance mode

USER1, USER2 User white balance mode

When selecting "ENTER" after select "AUTO" at "WHITE BAL", ATW settings are selectable.



Sets B and G Gain on user setting
 USER1 B-GAIN (Default: 139), R-GAIN (Default: 208)
 USER2 B-GAIN (Default: 185), R-GAIN (Default: 202)

Set the B gain and R gain for User White balance.

MANUAL Manual White balance mode

When selecting "ENTER" after select "MANUAL" at "WHITE BAL", the color temperature for the manual white balance is adjustable.



PUSH LOCK

Push to set White Balance

BACK LIGHT

OFF

Back light compensation is OFF

BLC

Back light compensation is ON

HLC

HLC (High Luminance Compensation) is enabled

PICT ADJUST

When selecting "ENTER" after select "PICT ADJUST", image processing settings are selectable.

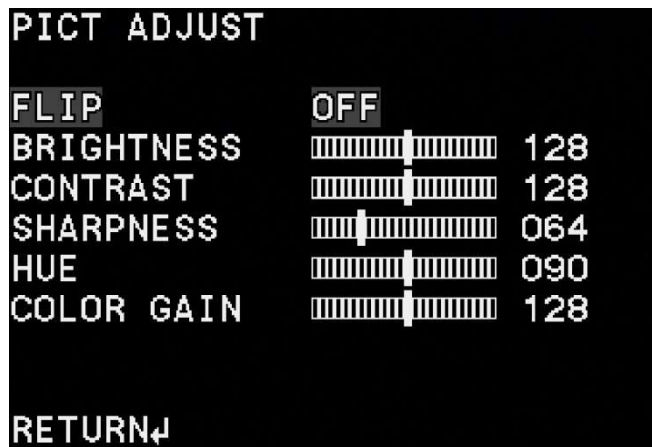

FLIP

OFF	Normal image
H-FLIP	Horizontal flip image
V-FLIP	Vertical flip image
HV-FLIP	Horizontal and vertical flip image
BRIGHTNESS	Set the brightness of the image (Default: 128)
CONTRAST	Set the contrast of the image (Default: 128)
SHARPNESS	Set the sharpness of the image (Default: 64)
HUE	Set the hue of the image (Default: 90)
COLOR GAIN	Set the color saturation of the image (Default: 128)

DEFOG

Default: OFF

When selecting "ENTER" after select "ON" at "DEFOG", defog setting is selectable.

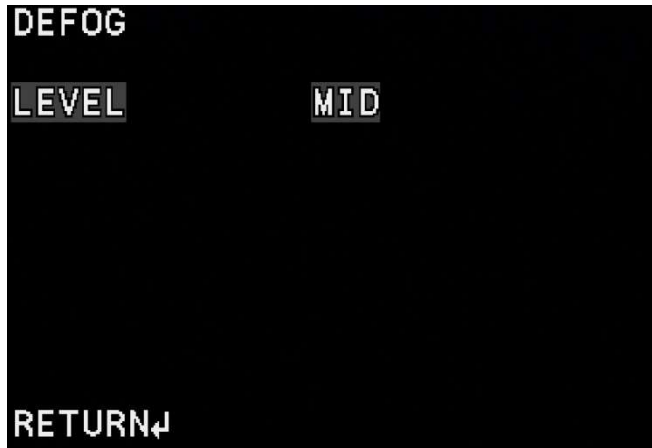

LEVEL

Set the defog level and sensitivity

- LOW Low
- MID Middle
- HIGH High

WDR/ATR

OFF

Set WDR and ATR function OFF

ATR

When selecting "ENTER" after select "ATR" at "WDR/ATR", ATR settings are selectable.



BRIGHTNESS Set the brightness highlight level

LOW Low

MID Middle(Default:)

HIGH High

CONTRAST Set the contrast highlight level

LOW Low

MID Middle

HIGH High

WDR

When selecting "ENTER" after select "WDR" at "WDR/ATR", WDR settings are selectable.



BRIGHTNESS Set the brightness compression level

LOW Low

MID Middle

HIGH High

CONTRAST Set the contrast highlight level

LOW Low

MID Middle

HIGH High

Day/Night

AUTO (Default)



DELAY CNT

Transition time between Day / Night (Default: 5)

DAY->NIGHT

Threshold for switch from Day to Night (Default: 90)

NIGHT->DAY

Threshold for switch from Night to Day (Default: 110)

DNR

Set the noise reduction settings

When selecting "ENTER" after select "ON" at "DNR", noise reduction settings are selectable.



MODE

OFF

Noise reduction is OFF

Y/C

Y/C Filter is ON (Default:)

Y

Y Filter is ON, C Filter is OFF

C

Y Filter is OFF, C Filter is ON

Y LEVEL

Set the Y filter level (Default: 4)

C LEVEL

Set the C filter level (Default:4)

PRIVACY

Set the privacy mask settings

When selecting "ENTER" after select "ON" at "PRIVACY", privacy mask settings are selectable.

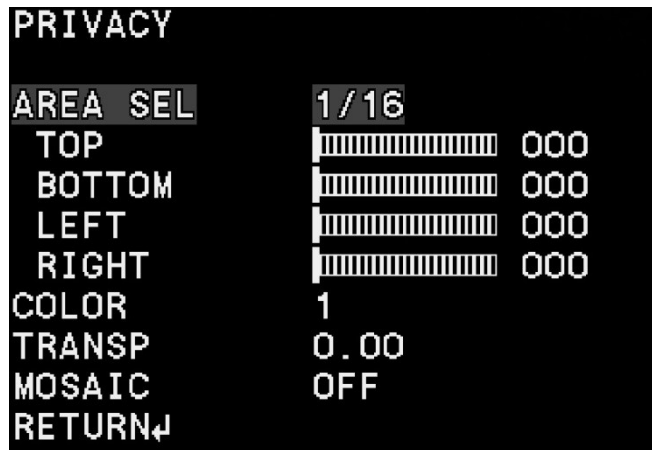

AREA SEL Select the privacy mask frame

TOP, BOTTOM, LEFT, RIGHT Set the privacy mask position (Default: 0)

COLOR Set the color for the privacy mask (Default: 1)

TRANSP (0.00 / 0.50 / 0.75 / 1.00) Set the transparent level for the privacy mask (Default: 0.00)

MOSAIC

OFF Mosaic is OFF (Default:)

ON Mosaic is ON

LANGUAGE

Select the language for the OSD menu from English, Douche, French, Russian, Portuguese or Spanish.

CAMERA RESET

Initialize all OSD settings

SAVE ALL

When selecting "SAVE ALL" after select "EXIT", save all OSD settings to the flash memory on the camera.
It is necessary to enable "OSD parameter Load" function to use saved settings



8 Revisions History

Rev	Date	Changes	Note
00	2018/05/21	New document	
01	2018/09/26	Revised Added cased models	

Note Product specifications would be modified without notification.

OMRON SENTECH CO., LTD.

9F, Ebina Prime Tower
9-50, Chuo 2 chome
Ebina-city, Kanagawa
243-0432 Japan
TEL 81-46-236-6660 FAX 81-46-236-6661
URL <http://www.sentech.co.jp/>