

コイン形二酸化マンガンリチウム電池
Coin manganese dioxide lithium batteries

CR2032R

■外形寸法 Dimensions(mm)

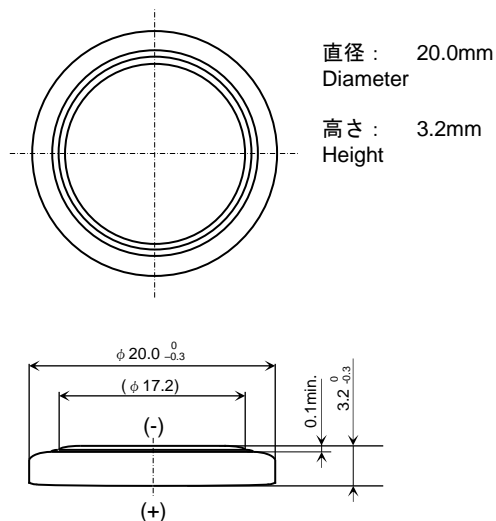

(Unit : mm)

■定格 Specifications

公称電圧 Nominal Voltage	3 V
公称容量 (終止電圧 2.0V) Nominal Capacity (2.0V cutoff)	200 mAh
推奨連続放電電流値 (容量利用率高) Recommended Continuous Discharge Current (High capacity usage rate)	≤3 mA
最大パルス放電電流(mA) *DOD50%時, 23°C, パルス長さ3sec, 2V以上 Maximum Pulse Discharge current (mA) *Assumption : Current to keep higher than 2V at 50% discharge with 23°C and pulse length 3sec.	50mA
標準質量 Weight	3 g
使用温度範囲 Operating Temperature	-30 ~ +70°C

用途 Applications

- IoT
 - ・ トラッキングデバイス
 - ・ センサ
 - ・ セキュリティ機器
- IoT
 - ・ Tracking devices
 - ・ Sensors
 - ・ Security

■放電負荷特性

Discharge Characteristics on Load

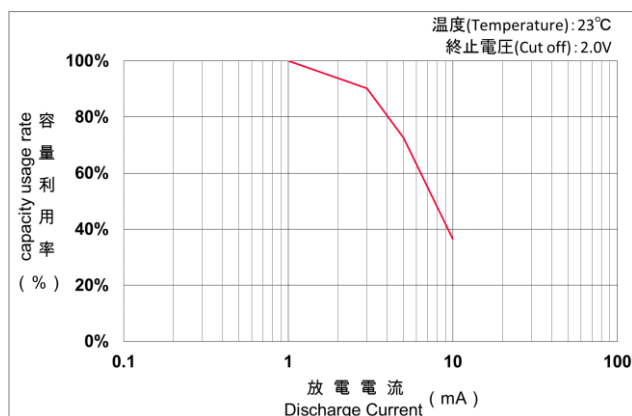

■放電特性

Discharge Characteristics

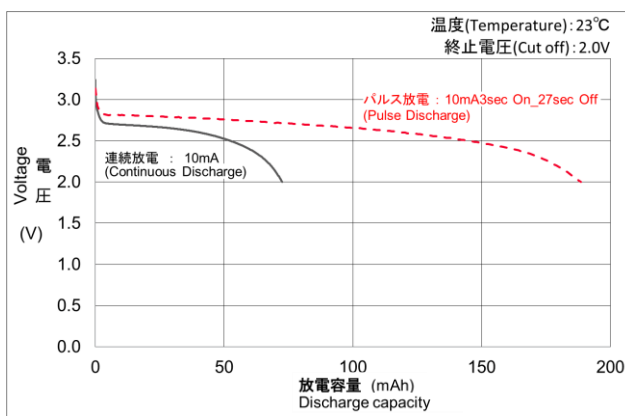

■ 放電負荷特性

Discharge Characteristics by Load

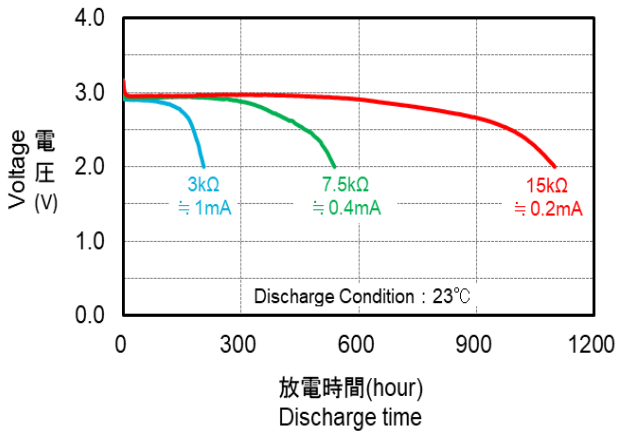

■ 放電温度特性

Discharge Characteristics by Temperature

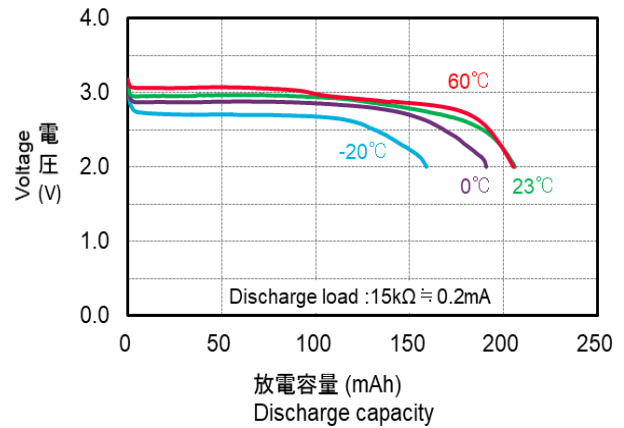

■ 閉路電圧特性

Closed Circuit Voltage by Temperature

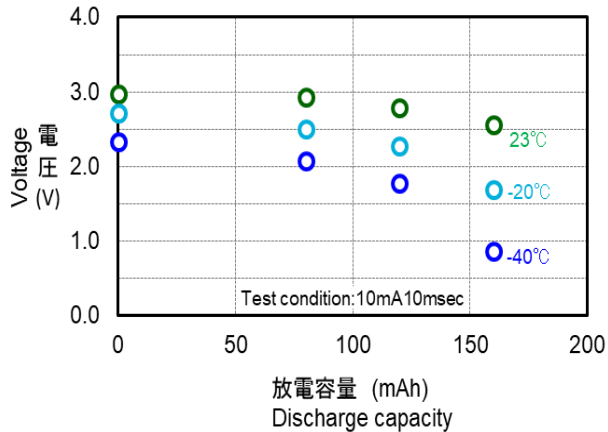

■ 内部抵抗

Impedance by Temperature

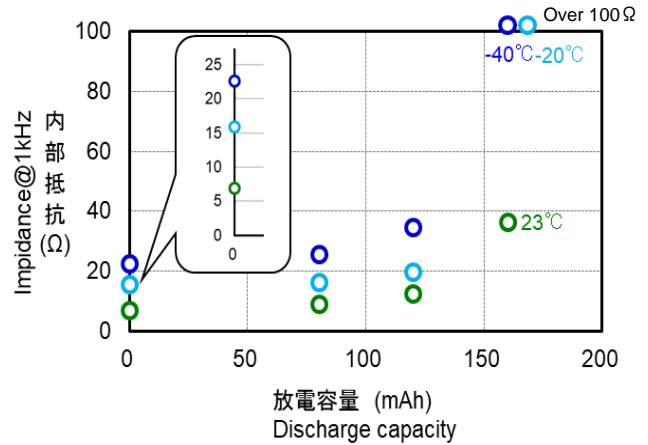

■ 自己放電特性

Self Discharge Characteristic by Temperature

注: 20°C未満の自己放電率は 20°Cと同じ自己放電率になります。
Note: The self-discharge rate of less than 20°C shows the same self-discharge rate as 20°C.

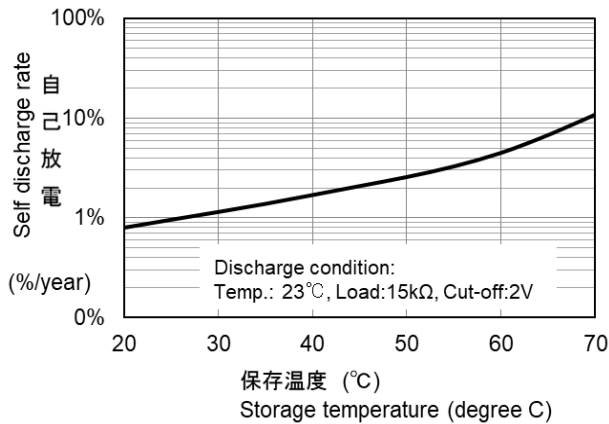

*記載のデータ及び数値は、参考値であり保証値ではありません。

*Data is not guaranteed, and is provided for reference purposes